

AVR 520 Audio/Video Receiver

OWNER'S MANUAL

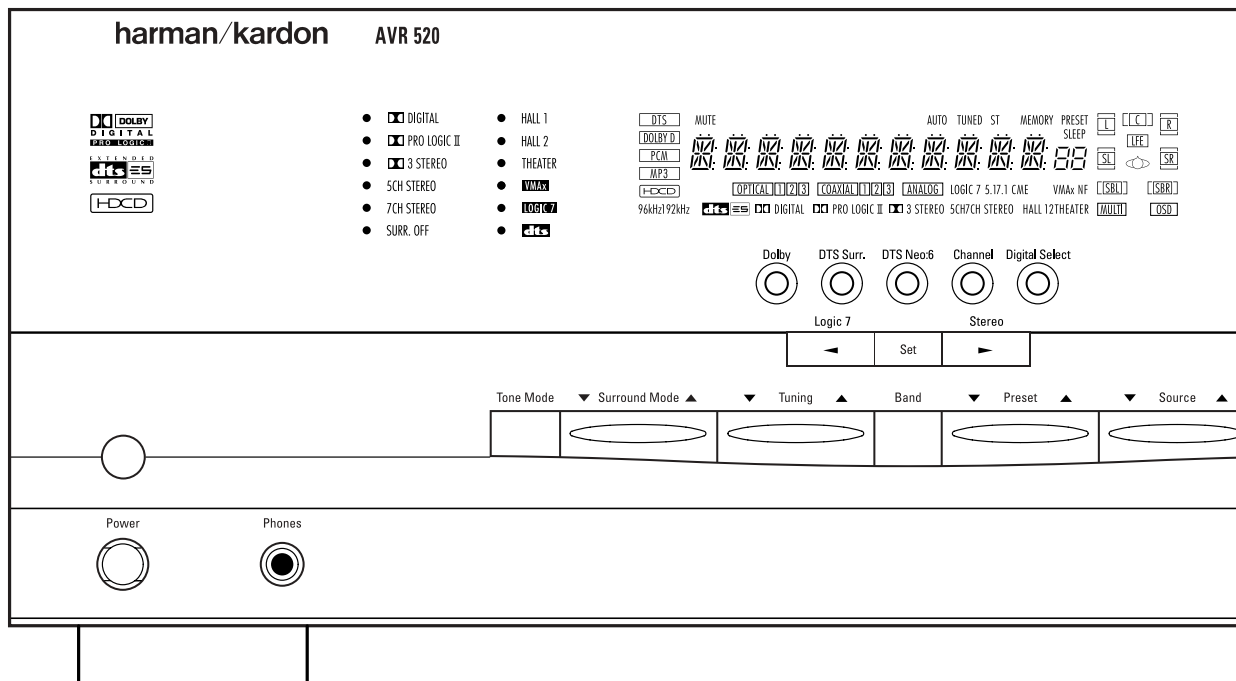

harman/kardon®

Power for the Digital Revolution®

AVR 520 Audio/Video Receiver

3	Introduction
4	Safety Information
4	Unpacking
5	Front Panel Controls
8	Front Panel Information Display
10	Rear Panel Connections
12	Main Remote Control Functions
15	Zone II Remote Control Functions
16	Installation and Connections
18	System Configuration
18	Speaker Placement
19	System Setup
20	Input Setup
20	Surround Setup
22	Speaker Setup
23	Delay Settings
24	Output Level Adjustment
25	Manual Output Level Adjustment
26	Operation
26	Surround Mode Chart
28	Basic Operation
28	Source Selection
28	Surround Mode Selection
29	Digital Audio Playback
31	Tuner Operation
32	Tape Recording
32	Front Panel Input/Output Connections
32	Output Level Trim Adjustment
33	6/8-Channel Direct Input
34	Advanced Features
34	Display Brightness
34	Turn-On Volume Level
34	Semi-OSD Settings
36	Multiroom Operation
37	Programming the Remote
37	Direct Code Entry
37	Auto Search Method
37	Code Readout
37	Learning Codes
38	Erasing Learned Codes
38	Macro Programming
39	Programmed Device Functions
40	Volume Punch-Through
40	Channel Control Punch-Through
41	Reassigning Device Control Selectors
42	Function List
44	Setup Code Tables
54	Troubleshooting Guide
54	Processor Reset
55	Technical Specifications

Typographical Conventions

In order to help you use this manual with the remote control, front panel controls and rear panel connections, certain conventions have been used.

EXAMPLE – (bold type) indicates a specific remote control or front panel button, or rear panel connection jack

EXAMPLE – (OCR type) indicates a message that is visible on-screen or on the front panel information display

1 – (number in a square) indicates a specific front panel control

① – (number in a circle) indicates a rear panel connection

Ⓛ – (number in an oval) indicates a button or indicator on the remote

A – (letter in a square) indicates an indicator in the front panel display

Ⓐ – (letter in an oval) indicates a button on the Zone II remote

Introduction

Thank you for choosing Harman Kardon!

With the purchase of a Harman Kardon AVR 520 you are about to begin many years of listening enjoyment. Designed to provide all the excitement and detail of movie soundtracks and every nuance of musical selections, the AVR 520 is truly a multichannel receiver for the new millennium.

The AVR 520 has been engineered so that it is easy to take advantage of all the power of its digital technology. On-screen menus, fully color coded connection jacks and terminals and our exclusive EzSet™ remote make installation fast and simple. However, to obtain the maximum enjoyment from your new receiver, we urge you to read this manual. A few minutes spent learning the functions of the various controls will enable you to take advantage of all the power the AVR 520 is able to deliver.

If you have any questions about this product, its installation or its operation, please contact your retailer or custom installer. They are your best local sources of information.

Description and Features

The AVR 520 is among the most versatile and multifeatured A/V receivers available, incorporating a wide range of listening options. In addition to Dolby Digital and DTS decoding for digital sources, a broad choice of Matrix surround-encoded or Stereo surround modes are available for use with sources such as CD, VCR, TV broadcasts and the AVR 520's own FM/AM tuner. Along with Dolby Pro Logic II, DTS Neo:6, Dolby 3 Stereo, and Hall and Theater modes, the AVR 520 offers Harman International's exclusive Logic 7 process in both 5.1 and 7.1 versions to create a wider, more enveloping field environment and more defined fly-overs and pans. Another Harman Kardon exclusive is VMaX, which uses proprietary processing to create an open, spacious sound field even when only two front speakers are available. Finally, the AVR 520 is among the very few A/V receivers that offer decoding of MP3 data, so that you may listen to the latest music selections directly from compatible computers or playback devices with the power and fidelity you expect from Harman Kardon.

In addition to providing a wide range of listening options, the AVR 520 is easy to configure so that it provides the best results with your speakers and specific listening-room environment. On-screen menus make it simple to enter settings for speaker configurations and bass

management, and the EzSet remote measures a system's sound levels and automatically calibrates them for perfectly balanced sound field presentation.

For the ultimate in flexibility, the AVR 520 features connections for six video devices, all with both composite and S-Video inputs. Two additional audio inputs are available, and a total of six digital inputs make the AVR 520 capable of handling all the latest digital audio sources. For compatibility with the latest HDTV video sources and progressive scan DVD players, the AVR 520 also features wide-bandwidth, low-crosstalk component video switching.

Coax and optical digital outputs are available for direct connection to digital recorders, and both the front panel analog audio/video and coaxial digital jacks may be switched to outputs for use with portable recorders – a Harman Kardon exclusive. Two video recording outputs, preamp-out and main amp-in jacks, and a color-coded eight-channel input make the AVR 520 virtually future-proof, with everything needed to accommodate tomorrow's new formats right on board.

The AVR 520's flexibility and power extend beyond your main home theater or listening room. The AVR 520 includes a sophisticated multizone control system that allows you to select one source for use in the main room and a different one in a second room. Complete control over volume is possible with a separate infrared control link. To make it easy to operate the AVR 520 from a remote room, a separate "Zone II" remote is included.

The AVR 520's powerful amplifier uses traditional Harman Kardon high-current design technologies to meet the wide dynamic range of any program selection.

Harman Kardon invented the high-fidelity receiver more than forty-seven years ago. With state-of-the-art circuitry and time-honored circuit designs, the AVR 520 is the perfect combination of the latest in digital audio technology, a quiet yet powerful analog amplifier in an elegant, easy-to-use package.

- **Dolby* Digital and Dolby Pro Logic* II Decoding, and the full suite of DTS® modes, including DTS-ES® 6.1 Discrete & Matrix and Neo:6® using the latest 24-bit, twin-core Crystal® DSP engine**
- **Harman Kardon's exclusive Logic 7® processing, available for the first time with both 7.1 and 5.1 processing in a variety of modes and two modes of VMaX®**
- **MP3 decoding for use with computers and digital audio players**
- **EzSet™ remote automatically sets output levels for optimum performance**
- **High-bandwidth, HDTV-compatible component video switching**
- **Front panel digital inputs and coax digital output capability for easy connection to portable digital devices and the latest video game consoles**
- **Multiple digital inputs and outputs**
- **Front panel analog A/V and coax digital jacks switchable to outputs for easy connection to portable digital devices and video game consoles**
- **On-screen menu and display system**
- **Complete multizone system with separate "Zone II" remote included**

CAUTION

**RISK OF ELECTRIC SHOCK
DO NOT OPEN**

CAUTION: To prevent electric shock, do not use this (polarized) plug with an extension cord, receptacle or other outlet unless the blades can be fully inserted to prevent blade exposure.



The lightning flash with arrowhead symbol, within an equilateral triangle, is intended to alert the user to the presence of uninsulated "dangerous voltage" within the product's enclosure that may be of sufficient magnitude to constitute a risk of electric shock to persons.



The exclamation point within an equilateral triangle is intended to alert the user to the presence of important operating and maintenance (servicing) instructions in the literature accompanying the appliance.

Safety Information

Important Safety Information

Verify Line Voltage Before Use

Your AVR 520 has been designed for use with 120-volt AC current. Connection to a line voltage other than that for which it is intended can create a safety and fire hazard and may damage the unit.

If you have any questions about the voltage requirements for your specific model, or about the line voltage in your area, contact your selling dealer before plugging the unit into a wall outlet.

Do Not Use Extension Cords

To avoid safety hazards, use only the power cord attached to your unit. We do not recommend that extension cords be used with this product. As with all electrical devices, do not run power cords under rugs or carpets or place heavy objects on them. Damaged power cords should be replaced immediately by an authorized service depot with a cord meeting factory specifications.

Handle the AC Power Cord Gently

When disconnecting the power cord from an AC outlet, always pull the plug; never pull the cord. If you do not intend to use the unit for any considerable length of time, disconnect the plug from the AC outlet.

Do Not Open the Cabinet

There are no user-serviceable components inside this product. Opening the cabinet may present a shock hazard, and any modification to the product will void your guarantee. If water or any metal object such as a paper clip, wire or a staple accidentally falls inside the unit, disconnect it from the AC power source immediately, and consult an authorized service station.

CATV or Antenna Grounding

If an outside antenna or cable system is connected to this product, be certain that it is grounded so as to provide some protection against voltage surges and static charges. Section 810 of the National Electrical Code, ANSI/NFPA No. 70-1984, provides information with respect to proper grounding of the mast and supporting structure, grounding of the lead-in wire to an antenna discharge unit, size of grounding conductors, location of antenna discharge unit, connection to grounding electrodes and requirements of the grounding electrode.

NOTE TO CATV SYSTEM INSTALLER: This reminder is provided to call the CATV (Cable TV) system installer's attention to article 820-

40 of the NEC that provides guidelines for proper grounding and, in particular, specifies that the cable ground shall be connected to the grounding system of the building, as close to the point of cable entry as possible.

Installation Location

- To ensure proper operation and to avoid the potential for safety hazards, place the unit on a firm and level surface. When placing the unit on a shelf, be certain that the shelf and any mounting hardware can support the weight of the product.
- Make certain that proper space is provided both above and below the unit for ventilation. If this product will be installed in a cabinet or other enclosed area, make certain that there is sufficient air movement within the cabinet. Under some circumstances a fan may be required.
- Do not place the unit directly on a carpeted surface.
- Avoid installation in extremely hot or cold locations, or in an area that is exposed to direct sunlight or heating equipment.
- Avoid moist or humid locations.
- Do not obstruct the ventilation slots on the top of the unit, or place objects directly over them.

Cleaning

When the unit gets dirty, wipe it with a clean, soft, dry cloth. If necessary, wipe it with a soft cloth dampened with mild soapy water, then a fresh cloth with clean water. Wipe dry immediately with a dry cloth. NEVER use benzene, aerosol cleaners, thinner, alcohol or any other volatile cleaning agent. Do not use abrasive cleaners, as they may damage the finish of metal parts. Avoid spraying insecticide near the unit.

Moving the Unit

Before moving the unit, be certain to disconnect any interconnection cords with other components, and make certain that you disconnect the unit from the AC outlet.

Important Information for the User

This equipment has been tested and found to comply with the limits for a Class-B digital device, pursuant to Part 15 of the FCC Rules. The limits are designed to provide reasonable protection against harmful interference in a residential installation. This equipment generates, uses and can radiate radio-frequency energy and, if not installed and used in accordance with the instructions, may cause harmful inter-

ference to radio communication. However, there is no guarantee that harmful interference will not occur in a particular installation. If this equipment does cause harmful interference to radio or television reception, which can be determined by turning the equipment off and on, the user is encouraged to try to correct the interference by one or more of the following measures:

- Reorient or relocate the receiving antenna.
- Increase the separation between the equipment and receiver.
- Connect the equipment into an outlet on a circuit different from that to which the receiver is connected.
- Consult the dealer or an experienced radio/TV technician for help.

This device complies with Part 15 of the FCC Rules. Operation is subject to the following two conditions: (1) this device may not cause harmful interference, and (2) this device must accept interference received, including interference that may cause undesired operation.

NOTE: Changes or modifications may cause this unit to fail to comply with Part 15 of the FCC Rules and may void the user's authority to operate the equipment.

Unpacking

The carton and shipping materials used to protect your new receiver during shipment were specially designed to cushion it from shock and vibration. We suggest that you save the carton and packing materials for use in shipping if you move, or should the unit ever need repair.

To minimize the size of the carton in storage, you may wish to flatten it. This is done by carefully slitting the tape seams on the bottom and collapsing the carton. Other cardboard inserts may be stored in the same manner. Packing materials that cannot be collapsed should be saved along with the carton in a plastic bag.

If you do not wish to save the packaging materials, please note that the carton and other sections of the shipping protection are recyclable. Please respect the environment and discard those materials at a local recycling center.

At this time you should remove the protective plastic film from the front-panel lens. Leaving the film in place may affect the performance of your remote control.

Front Panel Controls

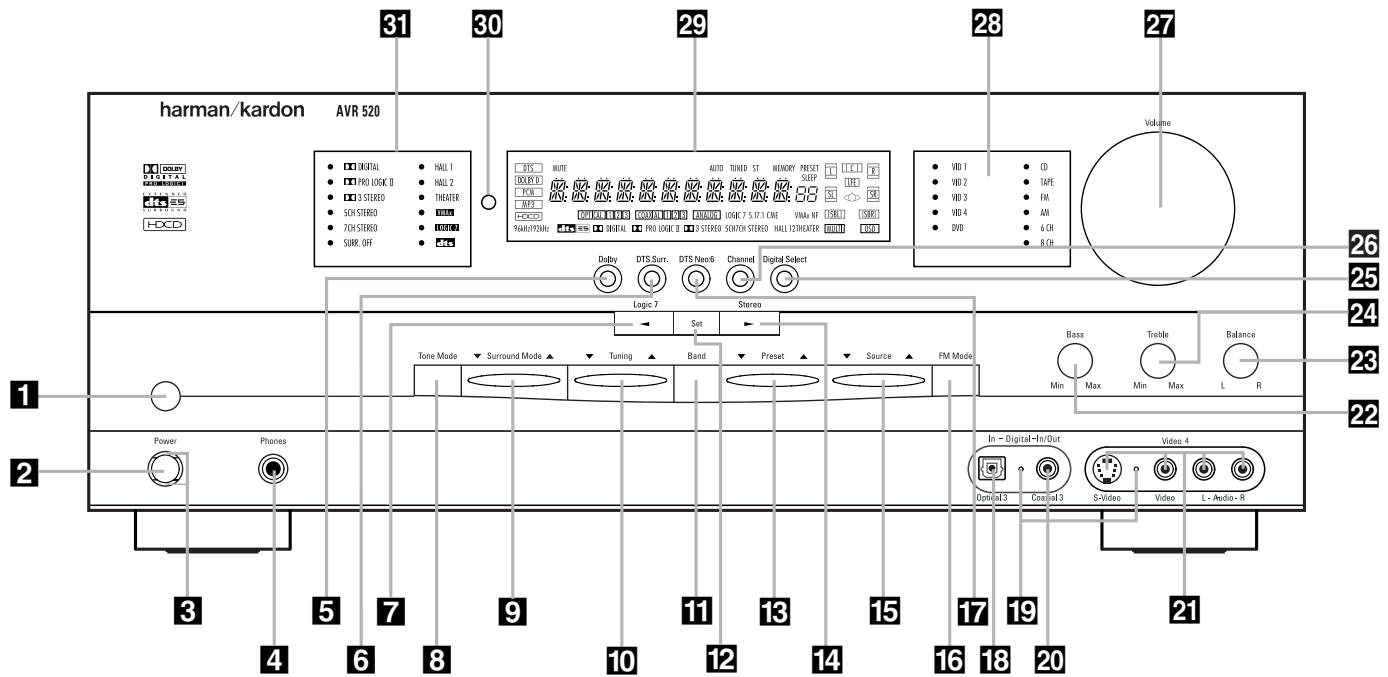

- 1** Main Power Switch
- 2** System Power Control
- 3** Power Indicator
- 4** Headphone Jack
- 5** Dolby Mode Selector
- 6** DTS Surround Mode Selector
- 7** Logic 7 Mode Selector / ◀ Button
- 8** Tone Mode
- 9** Surround Mode Selector
- 10** Tuning Selector
- 11** Tuner Band Selector
- 12** Set Button
- 13** Preset Station Selector
- 14** Stereo Mode Selector ▶ Button
- 15** Input Source Selector
- 16** FM Mode Selector
- 17** DTS Neo:6 Mode Selector
- 18** Digital Optical 3 Input
- 19** Input/Output Status Indicator
- 20** Digital Coax 3 Jack
- 21** Video 4 Input Jacks
- 22** Bass Control
- 23** Balance Control
- 24** Treble Control
- 25** Digital Select Button
- 26** Channel Select Button
- 27** Volume Control
- 28** Input Indicators
- 29** Main Information Display
- 30** Remote Sensor Window
- 31** Surround Mode Indicators

1 Main Power Switch: Press this button to apply power to the AVR 520. When the switch is pressed in, the unit is placed in a Standby mode, as indicated by the amber **Power Indicator 3** surrounding the **System Power Control 2**. This button MUST be pressed in to operate the unit. To turn the unit off and prevent the use of the remote control, this switch should be pressed until it pops out from the front panel so that the word "OFF" may be read at the top of the switch.

NOTE: This switch is normally left in the "ON" position.

2 System Power Control: When the **Main Power Switch 1** is "ON," press this button to turn on the AVR 520; press it again to turn

the unit off. Note that the **Power Indicator 3** surrounding the switch will turn green when the unit is on.

3 Power Indicator: This LED will be lit in amber when the unit is in the Standby mode to signal that the unit is ready to be turned on. When the unit is in operation, the indicator will turn green.

4 Headphone Jack: This jack may be used to listen to the AVR 520's output through a pair of headphones. Be certain that the headphones have a standard 1/4" stereo phone plug. Note that the main room speakers will automatically be turned off when the headphone jack is in use.

5 Dolby Mode Selector: Pressing this selector button cycles the AVR through the various Dolby surround modes. The first press of the button switches the surround mode to the last Dolby surround mode that was in use. Each subsequent press selects the next mode in the following order:

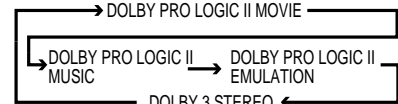

6 DTS Surround Mode Selector: Pressing this selector button cycles the AVR through the DTS surround modes. The first press of the button selects the last DTS surround mode that

Front Panel Controls

was in use. Each subsequent press selects the next DTS mode in the following order:

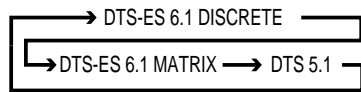

7 Logic 7 Mode Selector /◀ Button: This button has two functions: In normal use, press it to select one of the Logic 7 modes. When an adjustment is being made using the **Channel Select 26** or **Digital Select 25** buttons, this button may be pressed to scroll through the available options.

8 Tone Mode: Pressing this button enables or disables the Bass and Treble tone controls. When the button is pressed so that the words TONE IN appear in the **Main Information Display 29**, the settings of the **Bass 22** and **Treble 24** controls may be used to adjust the output signals. When the button is pressed so that the words TONE OUT appear in the **Main Information Display 29**, the output signal will be “flat,” without any bass or treble alteration, no matter how the actual **Bass** and **Treble Controls 22/24** are adjusted.

9 Surround Mode Selector: Press this button to change the surround mode by scrolling through the list of available modes. Note that depending on the type of input, some modes are not always available. (See page 26 for more information about surround modes.)

10 Tuning Selector: Press the left side of the button to tune lower-frequency stations and the right side of the button to tune higher-frequency stations. When a station with a strong signal is reached, the **TUNED Indicator W** will be lit in the **Main Information Display 29**.

To tune manually, tap the button lightly and note that the tuner will step up one frequency increment per button press. When the button is held for a few seconds you will note that the unit will quickly search the frequency band. Release it once the fast tuning starts; the tuner will automatically scan for the next station with an acceptable signal and then stop.

11 Tuner Band Selector: Pressing this button will automatically switch the AVR 520 to the Tuner mode. Pressing it again will switch between the AM and FM frequency bands. (See page 31 for more information on the tuner.)

12 Set Button: When making choices during the setup and configuration process, press this button to enter the desired setting as shown in the **Main Information Display 29** into the AVR 520’s memory.

13 Preset Station Selector: Press this button to scroll up or down through the list or stations that have been entered into the preset memory. (See page 32 for more information on tuner programming.)

14 Stereo Mode Selector /▶ Button: Pressing this selector button cycles through the stereo modes, and it is also used to turn off all surround processing and place the unit in a traditional two-channel Stereo mode. The first press selects 5-Channel Stereo, the next press selects 8-Channel Stereo, and the third press selects “SURROUND OFF,” which is true Stereo.

15 Input Source Selector: Press this button to change the input by scrolling up or down through the list of input sources.

16 FM Mode Selector: Press this button to select Auto or Manual tuning. When the button is pressed so that the **AUTO Indicator X** lights, the tuner will search for the next station with an acceptable signal when the **Tuning Selector 10 21 E** is pressed. When the button is pressed so that the **AUTO Indicator X** is not lit, each press of the **Tuning Selector 10 21 E** will increase the frequency. (See page 31 for more information on using the tuner.)

17 DTS Neo:6 Mode Selector: Pressing this selector button cycles the AVR through the various DTS Neo:6 modes, which extract a five-channel surround field from two-channel program material. The first press selects the last DTS Neo:6 surround mode that was in use, and each subsequent press selects the next mode in the following order:

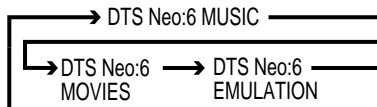

18 Digital Optical 3 Input: Connect the optical digital output of an audio or video product to this jack. When the input is not in use, be certain to keep the plastic cap installed to avoid dust contamination that might degrade future performance.

19 Input/Output Status Indicator: These LED indicators will normally light green to show that the front panel **Video 4 A/V 21** jacks or the **Coaxial 3 Digital 20** jacks are operating as inputs. When either of these jacks has been configured for use as an output, the indicator will turn red to show that the jack may be used for recording. (See page 20 for more information on configuring the front panel jacks as outputs, rather than inputs.)

20 Digital Coax 3 Jack: This jack is normally used for connection to the output of portable audio devices, video game consoles or other products that have a coax digital jack. It may also be configured as an output jack, to feed a digital signal to a CD-R, MiniDisc or other digital recording device. (See page 20 for information on configuring the Digital Coax 3 Jack as an output.)

21 Video 4 Input Jacks: These audio/video jacks may be used for temporary connection to video games or portable audio/video products such as camcorders and portable audio players.

22 Bass Control: Turn this control to modify the low-frequency output of the left/right channels by as much as ± 10 dB. Set this control to a suitable position for your taste or room acoustics.

23 Balance Control: Turn this control to change the relative volume for the front left/right channels.

NOTE: For proper operation of the surround modes, this control should be at the midpoint, or “12 o’clock”, position.

24 Treble Control: Turn this control to modify the high-frequency output of the left/right channels by as much as ± 10 dB. Set this control to a suitable position for your taste or room acoustics.

25 Digital Select Button: When playing a source that has a digital output, press this button to select between the **Optical 18 33** and **Coaxial 20 34 Digital** inputs. (See page 29 for more information on digital audio.)

26 Channel Select Button: Press this button to begin the process of trimming the channel output levels using an external audio source. (For more information on output level trim adjustment, see page 32.)

Front Panel Controls

27 Volume Control: Turn this knob clockwise to increase the volume, counterclockwise to decrease the volume. If the AVR 520 is muted, adjusting volume control will automatically release the unit from the silenced condition.

28 Input Indicators: A green LED will light to the left of the input that is currently the input source for the AVR 520.

29 Main Information Display: This display delivers messages and status indications to help you operate the receiver. (See pages 8 & 9 for a complete explanation of the Information Display.)

30 Remote Sensor Window: The sensor behind this window receives infrared signals from the remote control. Aim the remote at this area and do not block or cover it unless an external remote sensor is installed.

31 Surround Mode Indicators: A green LED will light in front of the surround mode that is currently in use.

Front Panel Information Display

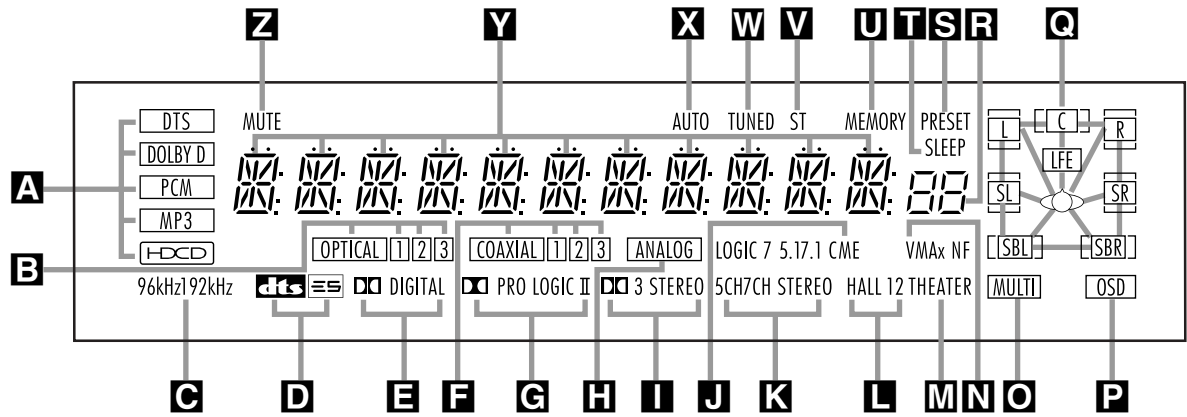

- A** Bitstream Indicators
- B** Optical Source Indicators
- C** Sample Rate Indicators
- D** DTS Mode Indicator
- E** Dolby Digital Indicator
- F** Coaxial Source Indicators
- G** Dolby Pro Logic II Indicator
- H** Analog Input Indicator
- I** Dolby 3 Stereo Indicator
- J** Logic 7 Mode Indicators
- K** 5-Channel/7-Channel Stereo Indicators
- L** Hall Mode Indicators
- M** Theater Mode Indicator
- N** VMAX Mode Indicators
- O** Multiroom Indicator
- P** OSD Indicator
- Q** Speaker/Channel Input Indicators
- R** Preset Number/Sleep Timer
- S** Preset Indicator
- T** Sleep Indicator
- U** Memory Indicator
- V** Stereo Indicator
- W** Tuned Indicator
- X** Auto Indicator
- Y** Main Information Display
- Z** Mute Indicator

A Bitstream Indicators: When the input is a digital source, one of these indicators will light to display the specific type of data signal in use.

B Optical Source Indicators: These indicators light to show when an Optical Digital Input has been selected.

C Sample Rate Indicators: One of these indicators will light when 96kHz or 192kHz source material is in use.

D DTS Mode Indicator: This indicator lights when a DTS-encoded source is playing.

E Dolby Digital Indicator: This indicator lights when a Dolby Digital source is being played.

F Coaxial Source Indicators: These indicators light to show when a Coaxial Digital Input has been selected.

G Dolby Pro Logic II Indicator: This indicator lights when the Dolby Pro Logic II mode has been selected.

NOTE: It is possible to see the Dolby Pro Logic II indicator lit simultaneously with the Dolby Digital indicator, even though the Dolby Digital surround mode has been selected. This is due to the specifications for Dolby Digital processing, which require that the Dolby Pro Logic II mode be applied when a 2-channel Dolby signal is detected. If you desire 5.1-channel audio, check the audio settings in the menus for your DVD disc to make sure that a 5.1-channel Dolby

Digital soundtrack has been selected.

H Analog Input Indicator: This indicator lights when an analog input source has been selected.

I Dolby 3 Stereo Indicator: This indicator lights when the Dolby 3 Stereo mode has been selected.

J Logic 7 Mode Indicators: These indicators light to indicate that one of the Logic 7 modes is in use. Along with the main Logic 7 indicator, either 5.1 or 7.1 will light to indicate the selected speaker configuration. One of the three letters to the far right of this segment will light to show which version of Logic 7 processing is in use: C for the Cinema mode, M for the Music mode and E for the Enhanced mode used with two-channel sources. The Enhanced mode is only available with the 5.1 speaker configuration. (See page 26 for a description of the Logic 7 modes.)

K 5-Channel/7-Channel Stereo Indicators: These indicators light to show if the 5-Channel or 7-Channel Stereo mode has been selected.

L Hall Mode Indicators: These indicators light when one of the Hall modes has been selected.

M Theater Mode Indicator: This indicator lights to show that the Theater mode is in use.

N VMAX Mode Indicators: One of these indicators lights when the VMAX mode is in use. **VMAX F** appears when the Far Field VMAX mode is selected; **VMAX N** appears when the Near Field VMAX mode is selected. (See page 27 for a description of the VMAX modes.)

O Multiroom Indicator: This indicator lights when the multiroom system is active. Note that it will remain lit when the multiroom system is in use even though the main room system is in the Standby mode and all other indicators are dark. (See page 36 for more information on the Multiroom system.)

P OSD Indicator: When the OSD system is in use, this indicator lights to remind you that the other indicators in this display do not function when the On-Screen Display is being used.

Q Speaker/Channel Input Indicators: These indicators are multipurpose, indicating either the speaker type selected for each channel or the incoming data-signal configuration. The left, center, right, right surround and left surround speaker indicators are composed of three boxes, while the subwoofer is a single box. The center box lights when a "Small" speaker is selected, and the two outer boxes light when "Large" speakers are selected. When none of the boxes are lit for the center, surround or subwoofer channels, no speaker has been selected for one of those positions. (See page 22 for more infor-

Front Panel Information Display

mation on configuring speakers.) The letters inside each of the center boxes display the active input channels. For standard analog inputs, only the L and R will light, indicating a stereo input. When a digital source is playing, the indicators will light to display the channels being received at the digital input. When the letters flash, the digital input has been interrupted. (See pages 23 & 30 for more information on the Channel Indicators.)

R Preset Number/Sleep Timer: When the tuner is in use, these numbers indicate the specific preset memory location in use. (See page 32 for more information on preset stations.) When the Sleep function is in use, these numbers show how many minutes remain before the unit goes into the Standby mode.

S Preset Indicator: This indicator lights when the tuner is in use to show that the **Preset Number/Sleep Timer R** is showing the station's preset memory number. (See page 32 for more information on tuner presets.)

T Sleep Indicator: This indicator lights when the Sleep function is in use. The numbers in the **Preset Number/Sleep Timer R** indicator will show the minutes remaining before the AVR 520 goes into the Standby mode. (See page 28 for more information on the Sleep function.)

U Memory Indicator: This indicator flashes when entering presets and other information into the tuner's memory.

V Stereo Indicator: This indicator lights when an FM station is being tuned in stereo.

W Tuned Indicator: This indicator lights when a station is being received with sufficient signal strength to provide acceptable listening quality.

X Auto Indicator: This indicator lights when the tuner's Auto mode is in use.

Y Main Information Display: This display shows messages relating to the status, input source, surround mode, tuner, volume level or other aspects of the AVR 520's operation.

Z Mute Indicator: This indicator lights to remind you that the AVR 520's output has been silenced by pressing the **Mute Button**  **43**. Press the Mute button again to return to the previously selected output level.

Rear Panel Connections

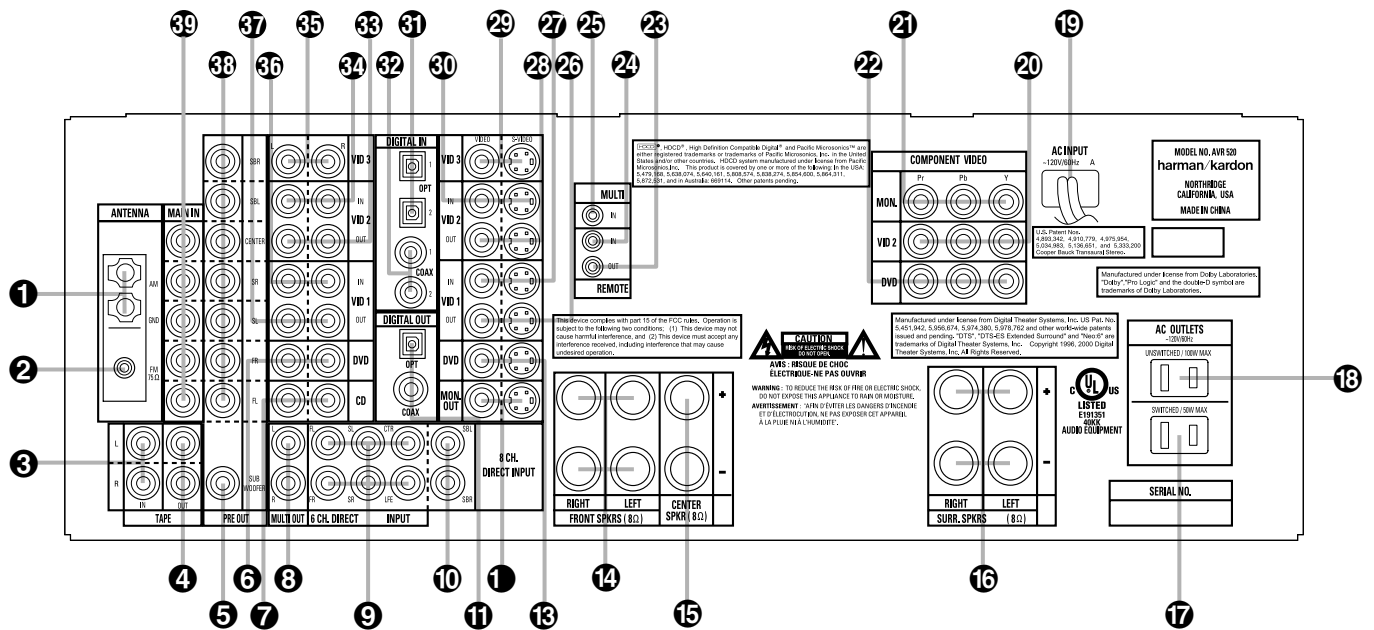

- 1 AM Antenna
- 2 FM Antenna
- 3 Tape Inputs
- 4 Tape Outputs
- 5 Subwoofer Output
- 6 DVD Audio Inputs
- 7 CD Inputs
- 8 Multiroom Outputs
- 9 6-Channel Direct Inputs
- 10 8 Channel Direct Inputs
- 11 Digital Audio Outputs
- 12 Video Monitor Outputs
- 13 DVD Video Inputs

- 14 Front Speaker Outputs
- 15 Center Speaker Outputs
- 16 Surround Speaker Outputs
- 17 Switched AC Accessory Outlet
- 18 Unswitched AC Accessory Outlet
- 19 AC Power Cord
- 20 Video 2 Component Video Inputs
- 21 Component Video Outputs
- 22 DVD Component Video Inputs
- 23 Remote IR Output
- 24 Remote IR Input
- 25 Multiroom IR Input
- 26 Video 1 Video Outputs

- 27 Video 1 Video Inputs
- 28 Video 2 Video Outputs
- 29 Video 3 Video Inputs
- 30 Video 2 Video Inputs
- 31 Optical Digital Inputs
- 32 Coaxial Digital Inputs
- 33 Video 2 Audio Outputs
- 34 Video 2 Audio Inputs
- 35 Video 3 Audio Inputs
- 36 Video 1 Audio Inputs
- 37 Video 1 Audio Outputs
- 38 Preamp Outputs
- 39 Amplifier Inputs

1 AM Antenna: Connect the AM loop antenna supplied with the receiver to these terminals. If an external AM antenna is used, make connections to the **AM** and **GND** terminals in accordance with the instructions supplied with the antenna.

2 FM Antenna: Connect the supplied indoor or an optional external FM antenna to this terminal.

3 Tape Inputs: Connect these jacks to the **PLAY/OUT** jacks of an audio recorder.

4 Tape Outputs: Connect these jacks to the **RECORD/INPUT** jacks of an audio recorder.

5 Subwoofer Output: Connect this jack to the line-level input of a powered subwoofer. If an external subwoofer amplifier is used, connect this jack to the subwoofer amplifier input.

6 DVD Audio Inputs: Connect these jacks to the analog audio jacks on a DVD or other video source.

7 CD Inputs: Connect these jacks to the output of a compact disc player or CD changer.

8 Multiroom Outputs: Connect these jacks to an optional audio power amplifier to listen to the source selected by the multiroom system in a remote room.

9 6-Channel Direct Inputs: When an optional, external processor or playback device with 5.1 audio capability is in use, connect the player's output jacks here.

NOTE: To assist in making the correct connections for multichannel input output and speaker connections, all connection jacks and terminals have been color coded in conformance with the latest CEA standards as follows:

- Front Left: White
- Front Right: Red
- Center: Green
- Surround Left: Blue

- Surround Right: Gray
- Surround Back Left: Brown
- Surround Back Right: Tan
- Subwoofer: Purple
- Digital Audio: Orange
- Composite Video: Yellow
- Component Video "Y": Green
- Component Video "Pr": Red
- Component Video "Pb": Blue

10 8-Channel Direct Inputs: When an optional, external processor or playback device with 6.1 or 7.1 audio capability is in use, connect the Surround Back Left and Surround Back Right channel outputs of the player to these input jacks.

11 Digital Audio Outputs: Connect these jacks to the matching digital input connector on a digital recorder such as a CD-R or MiniDisc recorder.

Rear Panel Connections

11 Video Monitor Outputs: Connect this jack to the composite or S-Video input of a TV monitor or video projector to view the on-screen menus and the output of any standard video source selected by the receiver's video switcher.

13 DVD Video Inputs: Connect these jacks to the composite or S-Video output jacks on a DVD or other video source.

14 Front Speaker Outputs: Connect these outputs to the matching + or – terminals on your left and right speakers. When making speaker connections always make certain to maintain correct polarity by connecting the red (+) terminals on the AVR 520 to the red (+) terminals on the speakers and the black (–) terminals on the AVR 520 to the black (–) terminals on the speakers. See page 16 for more information on speaker polarity.

15 Center Speaker Outputs: Connect these outputs to the matching + and – terminals on your center channel speaker. In conformance with the new CEA color code specification, the Green Terminal is the positive, or "+" terminal that should be connected to the red (+) terminal on speakers with the older color coding. Connect the black (–) terminal on the AVR to the black negative (–) terminal on your speaker. (See page 16 for more information on speaker polarity.)

16 Surround Speaker Outputs: Connect these outputs to the matching + and – terminals on your surround channel speakers. In conformance with the new CEA color code specification, the Blue terminal is the positive, or "+" terminal that should be connected to the red (+) terminal on the Surround Left speaker with older color coding, while the Gray terminal should be connected to the red (+) terminal on the Surround Right speaker with the older color coding. Connect the black (–) terminal on the AVR to the matching black negative (–) terminals for each surround speaker. (See page 17 for more information on speaker polarity.)

17 Switched AC Accessory Outlet: This outlet may be used to power any device you wish to have turned on when the AVR 520 is turned on with the **System Power Control Button** 2.

18 Unswitched AC Accessory Outlet: This outlet may be used to power any AC device. The power will remain on at this outlet regardless of whether the AVR 520 is on or off.

NOTE: The total power consumption of all devices connected to the accessory outlets should not exceed 100 watts.

19 AC Power Cord: Connect the AC plug to an unswitched AC wall output.

20 Video 2 Component Video Inputs: Connect the Y/Pr/Pb component video outputs of an HDTV Set-top converter, satellite receiver, or other video source device with component video outputs to these jacks.

21 Component Video Outputs: Connect these outputs to the component video inputs of a video projector or monitor. When a source connected to one of the two **Component Video Inputs** 20/22 is selected the signal will be sent to these jacks.

22 DVD Component Video Inputs: Connect the Y/Pr/Pb component video outputs of a DVD player to these jacks.

23 Remote IR Output: This connection permits the IR sensor in the receiver to serve other remote controlled devices. Connect this jack to the "IR IN" jack on Harman Kardon (or other compatible) equipment.

24 Remote IR Input: If the AVR 520's front-panel IR sensor is blocked due to cabinet doors or other obstructions, an external IR sensor may be used. Connect the output of the sensor to this jack.

25 Multiroom IR Input: Connect the output of an IR sensor in a remote room to this jack to operate the AVR 520's multiroom control system.

26 Video 1 Video Outputs: Connect these jacks to the **RECORD/INPUT** composite or S-Video jack on a VCR.

27 Video 1 Video Inputs: Connect these jacks to the **PLAY/OUT** composite or S-Video jacks on a VCR or other video source.

28 Video 2 Video Outputs: Connect these jacks to the **RECORD/INPUT** composite or S-Video jacks on a VCR.

29 Video 3 Video Inputs: Connect these jacks to the **PLAY/OUT** composite or S-Video jacks on a VCR or other video source.

30 Video 2 Video Inputs: Connect these jacks to the **PLAY/OUT** composite or S-Video jacks on a VCR or other video source.

31 Optical Digital Inputs: Connect the optical digital output from a DVD player, HDTV receiver, the S/P-DIF output of a compatible computer sound card playing MP3 files or streams, LD player or CD player to these jacks. The signal may be either a Dolby Digital signal, a DTS signal or a standard PCM digital source.

32 Coaxial Digital Inputs: Connect the coax digital output from a DVD player, HDTV receiver, the S/P-DIF output of a compatible computer sound card playing MP3 files or streams, LD player or CD player to these jacks. The signal may be either a Dolby Digital signal, DTS signal or a standard PCM digital source. Do not connect the RF digital output of an LD player to these jacks.

33 Video 2 Audio Outputs: Connect these jacks to the **RECORD/INPUT** audio jacks on a VCR or other video source.

34 Video 2 Audio Inputs: Connect these jacks to the **PLAY/OUT** audio jacks on a VCR or other video source.

35 Video 3 Audio Inputs: Connect these jacks to the **PLAY/OUT** audio jacks on a VCR or other video source.

36 Video 1 Audio Inputs: Connect these jacks to the **PLAY/OUT** audio jacks on a VCR or other video source.

37 Video 1 Audio Outputs: Connect these jacks to the **RECORD/INPUT** audio jacks on a VCR.

38 Preamp Outputs: When the jumper pins that link the **Amplifier Inputs** 39 with these outputs are removed, these jacks may be connected to an external power amplifier.

39 Amplifier Inputs: When the jumper pins that link the **Preamp Outputs** 38 with these inputs are removed, these jacks may be used to connect an external source or the AVR 520's multiroom system to the internal amplifiers.

Main Remote Control Functions

- 1 Power Off Button
- 2 IR Transmitter Window
- 3 Program/SPL Indicator
- 4 Power On Button
- 5 Input Selectors
- 6 AVR Selector
- 7 AM/FM Tuner Select
- 8 6-Channel/8-Channel Direct Input
- 9 Test Button
- 10 Sleep Button
- 11 Surround Mode Selector
- 12 Night Mode
- 13 Channel Select Button
- 14 ▲/▼ Buttons
- 15 ◀ Button
- 16 Set Button
- 17 Digital Select
- 18 Numeric Keys
- 19 Tuner Mode
- 20 Direct Button
- 21 Tuning Up/Down
- 22 OSD Button
- 23 Dolby Mode Select Button
- 24 DTS Digital Mode Selector
- 25 Logic 7 Mode Select Button
- 26 Transport Controls
- 27 Light Button
- 28 Skip Up/Down Button
- 29 Stereo Mode Select Button
- 30 DTS Neo:6 Mode Select
- 31 Macro Buttons
- 32 Disc Skip Button
- 33 Preset Up/Down
- 34 Clear Button
- 35 Memory Button
- 36 Delay/Prev. Ch.
- 37 ▶ Button
- 38 Speaker Select
- 39 Multiroom
- 40 Volume Up/Down
- 41 SPL Indicator Select
- 42 Learn Button
- 43 Mute
- 44 EzSet Sensor Microphone

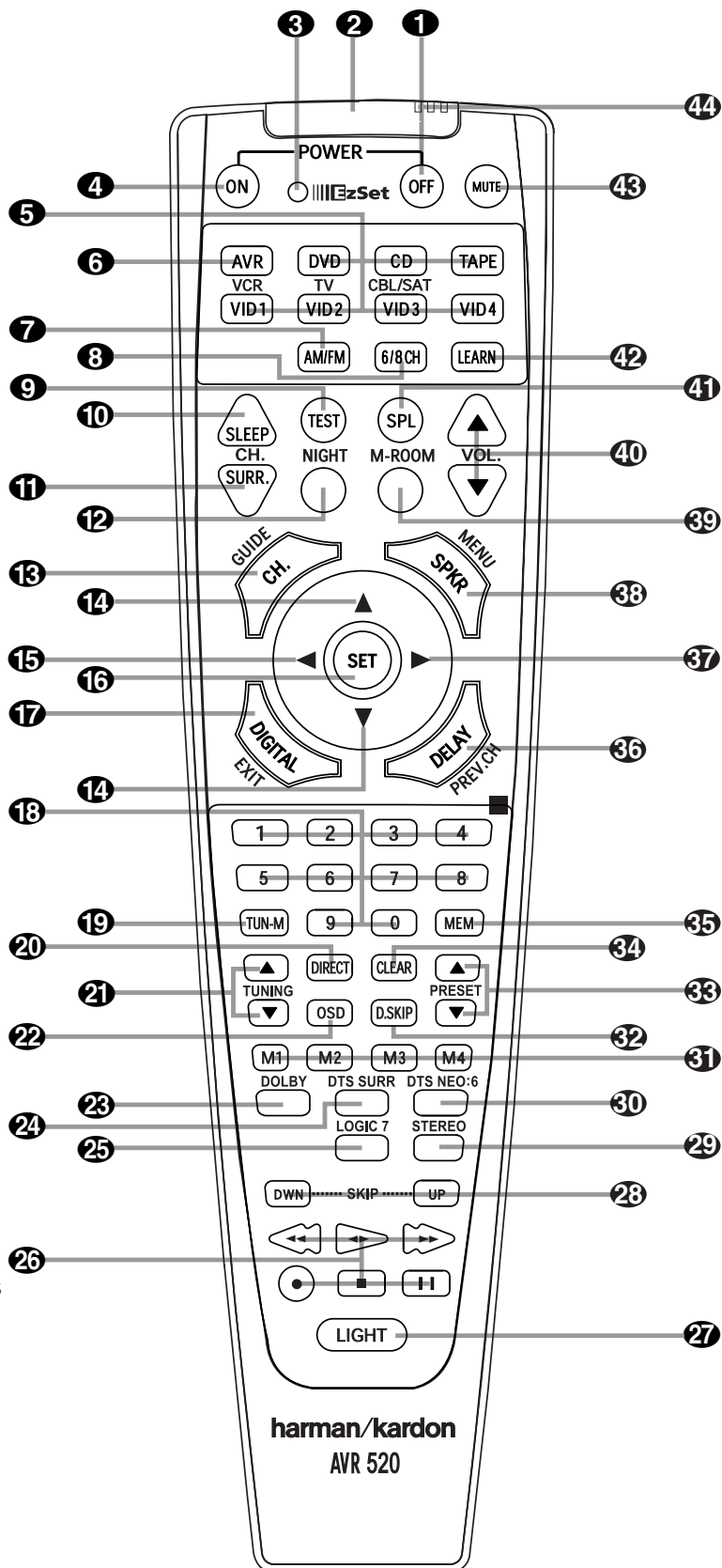

NOTE: The function names shown here are each button's feature when used with the AVR 520. Most buttons have additional functions when used with other devices. See pages 42–43 for a list of these functions.

Main Remote Control Functions

IMPORTANT NOTE: The AVR 520's remote may be programmed to control up to eight devices, including the AVR 520. Before using the remote, it is important to remember to press the **Input Selector Button 5** that corresponds to the unit you wish to operate. In addition, the AVR 520's remote is shipped from the factory to operate the AVR 520 and most Harman Kardon CD or DVD players and cassette decks. The remote is also capable of operating a wide variety of other products using the control codes that are part of the remote. Before using the remote with other products, follow the instructions on pages 37–41 to program the proper codes for the products in your system.

It is also important to remember that many of the buttons on the remote take on different functions, depending on the product selected using the Device Control Selectors. The descriptions shown here primarily detail the functions of the remote when it is used to operate the AVR 520. (See page 39 for information about alternate functions for the remote's buttons.)

1 Power Off Button: Press this button to place the AVR 520 or a selected device in the Standby mode. Note that this will turn off the main room functions, but if the Multiroom system is activated, it will continue to function.

2 IR Transmitter Window: Point this window towards the AVR 520 when pressing buttons on the remote to make certain that infrared commands are properly received.

3 Program/SPL Indicator: This three-color indicator is used to guide you through the process of programming the remote or learning commands from a remote into the AVR 520's remote code memory and it is also used as a level indicator when using the remote's EzSet capabilities. (See page 24 for more information on setting output levels, and see page 37 for information on programming the remote.)

4 Power On Button: Press this button to turn on the power to a device selected by pressing one of the **Input Selectors 5**.

5 Input Selectors: Pressing one of these buttons will perform three actions at the same time. First, if the AVR 520 is not turned on, this will power up the unit. Next, it will select the source shown on the button as the input to the AVR 520. Finally, it will change the remote control so that it controls the device selected. After pressing one of these buttons you must press the **AVR Selector Button 6** again to operate the AVR 520's functions with the remote.

6 AVR Selector: Pressing this button will switch the remote so that it will operate the AVR 520's functions. If the AVR 520 is in the Standby mode, it will also turn the AVR 520 on.

7 AM/FM Tuner Select: Press this button to select the AVR 520's tuner as the listening choice. Pressing this button when the tuner is already in use will select between the AM and FM bands.

8 6-Channel/8 Channel Direct Input: Press this button to select the device connected to the **6-Channel Direct Inputs 9** or the **8-Channel Direct Inputs 9/10**. (See page 33 for more information.)

9 Test Button: Press this button to begin the sequence used to calibrate the AVR 520's output levels. (See page 24 for more information on calibrating the AVR 520.)

10 Sleep Button: Press this button to place the unit in the Sleep mode. After the time shown in the display, the AVR 520 will automatically go into the Standby mode. Each press of the button changes the time until turn-off in the following order:

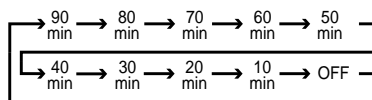

Note that this button is also used to change channels on your TV when the TV is selected.

When the AVR 520 remote is being programmed with the codes to operate another device, this button is also used in the "Auto Search" process. (See page 37 for more information on programming the remote.)

11 Surround Mode Selector: Press this button to begin the process of changing the surround mode. After the button has been pressed, use the **▲/▼ Buttons 14** to select the desired surround mode. (See page 28 for more information.) Note that this button is also used to tune channels when the TV is selected using the device **Input Selector 5**.

When the AVR 520 remote is being programmed with the codes of another device, this button is also used in the "Auto Search" process. (See page 37 for more information on programming the remote.)

12 Night Mode: Press this button to activate the Night mode. This mode is available in specially encoded digital sources, and it preserves

dialog (center channel) intelligibility at low volume levels.

13 Channel Select Button: This button is used to start the process of setting the AVR 520's output levels to an external source. Once this button is pressed, use the **▲/▼ Buttons 14** to select the channel being adjusted, then press the **Set Button 16**, followed by the **▲/▼ Buttons 14** again, to change the level setting. (See page 32 for more information.)

14 ▲/▼ Buttons: These multipurpose buttons are used to change or scroll through items in the on-screen menus, make configuration settings such as digital inputs or delay timing, or to select surround modes. When changing a setting, first press the button for the function or setting to be changed (e.g., press the **Surround Mode Selector 11** to select a soundfield mode or the **Digital Select Button 17** to change a digital input) and then press one of these buttons to scroll through the list of options or to increase or decrease a setting. The sections in this manual describing the individual features and functions contain specific information on using these buttons for each application.

15 ◀ Button: This button is used to change the menu selection or setting during some of the setup procedures for the AVR 520.

16 Set Button: This button is used to enter settings into the AVR 520's memory. It is also used in the setup procedures for delay time, speaker configuration and channel output level adjustment.

17 Digital Select: Press this button to assign one of the digital inputs **31 32 18/20** to a source. (See page 29 for more information on using digital inputs.)

18 Numeric Keys: These buttons serve as a ten-button numeric keypad to enter tuner preset positions. They are also used to select channel numbers when TV, Cable or SAT has been selected on the remote, or to select track numbers on a CD, DVD or LD player, depending on how the remote has been programmed.

19 Tuner Mode: Press this button when the tuner is in use to select between automatic tuning and manual tuning. When the button is pressed so that the **AUTO Indicator X** goes out, pressing the **Tuning Buttons 21/10/E** will move the frequency up or down in single-step increments. When the FM band is in use, pressing this button when a station's signal is

Main Remote Control Functions

weak will change to monaural reception. (See page 31 for more information.)

20 Direct Button: Press this button when the tuner is in use to start the sequence for direct entry of a station's frequency. After pressing the button, simply press the proper **Numeric Keys 18** to select a station. (See page 32 for more information on the tuner.)

21 Tuning Up/Down: When the tuner is in use, these buttons will tune up or down through the selected frequency band. If the **Tuner Mode Button 19 16** has been pressed so that the **AUTO Indicator X** is illuminated, pressing and holding either of the buttons for three seconds will cause the tuner to seek the next station with acceptable signal strength for quality reception. When the **AUTO Indicator X** is NOT illuminated, pressing these buttons will tune stations in single-step increments. (See page 31 for more information.)

22 OSD Button: Press this button to activate the On-Screen Display (OSD) system used to set up or adjust the AVR 520's parameters.

23 Dolby Mode Selector: This button is used to select from among the available Dolby Surround processing modes. Each press of this button will select one of the Dolby Pro Logic II modes or Dolby 3 Stereo. When a Dolby Digital encoded source is in use, the Dolby Digital mode may also be selected. (See page 26 for the available Dolby surround mode options.)

24 DTS Digital Mode Selector: When a DTS-encoded digital source is selected, each press of this button will scroll through the available DTS modes. The specific choice of modes will vary according to whether or not the source material contains DTS-ES 6.1 Discrete encoding. When a DTS source is not in use, this button has no function. (See page 40 for the available DTS Digital options.)

25 Logic 7 Selector: Press this button to select from among the available Logic 7 surround modes. (See page 26 for the available Logic 7 options.)

26 Transport Controls: These buttons do not have any functions for the AVR 520, but they may be programmed for the forward/reverse play operation of a wide variety of CD or DVD players, and audio or video cassette recorders. (See page 40 for more information.)

27 Light Button: Press this button to activate the remote's backlight for ease of use in darkened rooms.

28 Skip Up/Down Buttons: These buttons do not have a direct function with the AVR 520, but when used with a compatibly programmed CD or DVD changer they will change the disc currently being played in the changer.

31 Macro Buttons: Press these buttons to store or recall a "Macro", which is a preprogrammed sequence of commands stored in the remote. (See page 38 for more information on storing and recalling macros.)

32 Disc Skip Buttons: This button has no direct function for the AVR 520 but is most often used to change to the next disc in a CD or DVD player when the remote is programmed for that type of device. (See page 37 for more information on using the remote with products other than the AVR 520.)

33 Preset Up/Down: When the tuner is in use, press these buttons to scroll through the stations programmed into the AVR 520's memory. When some source devices, such as CD players, VCRs and cassette decks, are selected using the device **Input Selectors 5**, these buttons may function as Chapter Step or Track Advance.

34 Clear Button: Press this button to clear incorrect entries when using the remote to directly enter a radio station's frequency.

35 Memory Button: Press this button to enter a radio station into the AVR 520's preset memory. Once the **MEMORY Indicator U** flashes, you have five seconds to enter a preset memory location using the **Numeric Keys 18**. (See page 31 for more information.)

36 Delay/Prev Ch.: Press this button to begin the process for setting the delay times used by the AVR 520 when processing surround sound. After pressing this button, the delay times are entered by pressing the **Set Button 16** and then using the **▲/▼ Buttons 14** to change the setting. Press the **Set Button 16** again to complete the process. (See page 23 for more information.)

37 ► Button: Press this button to change a setting or selection when configuring many of the AVR 520's settings.

38 Speaker Select: Press this button to begin the process of configuring the AVR 520's bass management system for use with the type of speakers used in your system. Once the button has been pressed, use the

▲/▼ Buttons 14 to select the channel you wish to set up. Press the **Set Button 16** and then select another channel to configure. When all adjustments have been completed, press the **Set Button 16** twice to exit the settings and return to normal operation. (See page 22 for more information.)

39 Multiroom: Press this button to activate the multiroom system or to begin the process of changing the input or volume level for the second zone. (See page 36 for more information on the Multiroom system.)

40 Volume Up/Down: Press these buttons to raise or lower the system volume.

41 SPL Indicator Select: This button activates the AVR 520's EzSet function to quickly and accurately calibrate the AVR 520's output levels. Press and hold the button for three seconds and then release it. Note that the test tone will begin circulating, and the **Program/SPL Indicator 3** will change colors. During this sequence, EzSet will automatically adjust the output levels for all channels until they are equal, as shown by the **Program/SPL Indicator** lighting green for each channel. Press this button again when the adjustment is complete to turn off the test tone. (See page 24 for more information on EzSet.)

42 Learn Button: Press this button to begin the process of "learning" the codes from another product's remote into the AVR 520's remote. (See page 37 for more information on using the remote's learning function.)

43 Mute: Press this button to momentarily silence the AVR 520 or TV set being controlled, depending on which device has been selected. When the AVR 520 remote is being programmed to operate another device, this button is pressed with the **Input Selector Button 5** to begin the programming process. (See page 37 for more information on programming the remote.)

44 EzSet Sensor Microphone: The sensor microphone for the EzSet microphone is behind these slots. When using the remote to calibrate speaker output levels using EzSet, be sure that you do not hold the remote in a way that covers these slots. (See page 24 for more information on using EzSet.)

Zone II Remote Control Functions

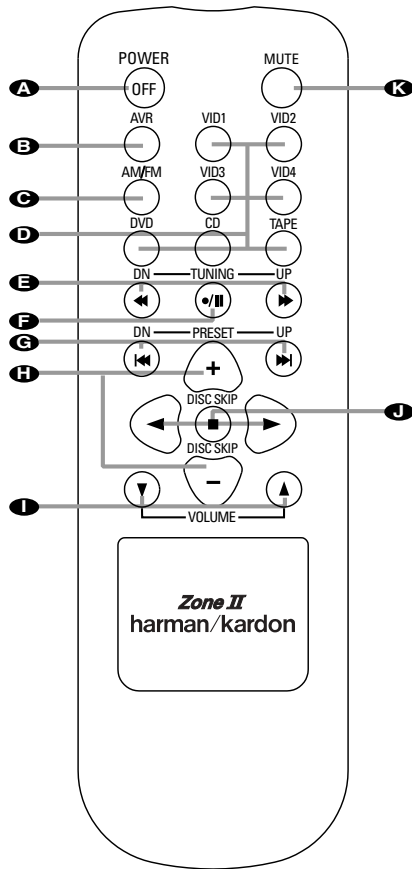

- A** Power Off
- B** AVR Selector
- C** AM/FM Tuner Select
- D** Input Selectors
- E** Tuning Up/Down – Fast Play
- F** Record/Pause
- G** Preset/Track Skip
- H** Disc Skip
- I** Volume Up/Down
- J** Play Forward/Reverse/Stop
- K** Mute

A Power Off: When used in the room where the AVR 520 is located, press this button to place the unit in Standby. When it is used in a remote room with a sensor that is connected to the **Multi IR** jack 25, this button turns the Multiroom system on and off.

B AVR Selector: Press this button to turn on the AVR 520. The input in use when the unit was last on will be selected.

C AM/FM Tuner Select: Press this button to select the Tuner as the input to the Multiroom system. Press it again to change between the AM and FM bands.

D Input Selectors: When the AVR 520 is off, press one of these buttons to select a specific input and turn the unit on. When the unit is already in use, pressing one of these buttons will change the input.

E Tuning Up/Down – Fast Play: When this remote is used in the same room as the AVR 520, these buttons may be used to change the frequency of the tuner. These buttons may also control the Fast Play or Fast Reverse functions of compatible Harman Kardon CD, DVD or cassette decks in the same room, or from a remote room when an IR link is connected to the AVR 520.

F Record/Pause: Press this button to activate the Record or Pause function on compatible Harman Kardon CD, DVD or Cassette Deck products.

G Preset Up/Down – Track Skip: When the AVR 520's tuner is selected as the input source, these buttons will move up or down through the list of stations that have been stored in the preset memory. When a CD or DVD changer or player is selected, these buttons activate the Forward or Reverse Track or Chapter Skip functions.

H Disc Skip: Press this button to change discs on compatible Harman Kardon CD or DVD changer or players.

I Volume Up/Down: When used in the room where the AVR 520 is located, press this button to raise or lower the volume in that room. When it is used in a remote room with a sensor that is connected to the **Multiroom IR** jack 25, this button will raise or lower the volume in the remote room.

J Play Forward/Reverse/Stop: Press these buttons to control compatible Harman Kardon CD, DVD or cassette players.

K Mute: When used in the room where the AVR 520 is located, press this button to temporarily silence the unit. When it is used in a remote room with a sensor that is connected to the **Multiroom IR** jack 25, this button will temporarily silence the feed to the remote room only. Press the button again to return to the previous volume level.

NOTE: The Zone II remote may be used in either the same room where the AVR 520 is located, or it may be used in a separate room with an optional infrared sensor that is connected to the AVR 520's **Multiroom IR Input Jack** 25. When it is used in the same room as the AVR 520, it will control the functions of the AVR 520 or any compatible Harman Kardon products in that room. When it is used in a separate room via a sensor connected to the **Multiroom IR Jack** 25, the buttons for power, input source, volume and mute will control the source and volume for the second zone, as connected to the **Multiroom Out Jacks** 8. (See page 36 for complete information on using the Multiroom system.)

Installation and Connections

System Installation

After unpacking the unit, and placing it on a solid surface capable of supporting its weight, you will need to make the connections to your audio and video equipment.

IMPORTANT NOTE: For your personal safety and to avoid possible damage to your equipment and speakers, it is always good practice to turn off and unplug the AVR and ALL source equipment from the AC output before making any audio or video system connections.

Audio Equipment Connections

We recommend that you use high-quality interconnect cables when making connections to source equipment and recorders to preserve the integrity of the signals.

1. Connect the analog output of a CD player to the **CD Inputs 7**.

NOTE: When the CD player has both fixed and variable audio outputs, it is best to use the fixed output unless you find that the input to the receiver is so low that the sound is noisy, or so high that the signal is distorted.

2. Connect the analog Play/Out jacks of a cassette deck, MD, CD-R or other audio recorder to the **Tape Input Jacks 3**. Connect the analog Record/In jacks on the recorder to the **Tape Output Jacks 4** on the AVR 520.

3. Connect the output of any digital sources such as a CD or DVD changer or player, advanced video game, a digital satellite receiver, HDTV tuner or digital cable set-top box to the **Optical and Coaxial Digital Inputs 31 32 18 20**.

4. Connect the coaxial or optical **Digital Audio Outputs 11** on the rear panel of the AVR 520 to the matching digital input connections on a CD-R or MiniDisc recorder.

5. Assemble the AM Loop Antenna supplied with the unit as shown below. Connect it to the **AM and GND Screw Terminals 1**.

6. Connect the supplied FM antenna to the **FM (75-ohm) Connection 2**. The FM antenna may be an external roof antenna, an inside powered or wire-lead antenna or a connection from a cable TV system. Note that if the antenna or connection uses 300-ohm twin-lead cable, you must use the 300-ohm-to-75-ohm

adapter supplied with the unit to make the connection.

7. Connect the front, center and surround speaker outputs **14 15 16** to the respective speakers.

To ensure that all the audio signals are carried to your speakers without loss of clarity or resolution, we suggest that you use high-quality speaker cable. Many brands of cable are available and the choice of cable may be influenced by the distance between your speakers and the receiver, the type of speakers you use, personal preferences and other factors. Your dealer or installer is a valuable resource to consult in selecting the proper cable.

Regardless of the brand of cable selected, we recommend that you use a cable constructed of multistrand copper with a gauge of 14 or smaller. Remember that in specifying cable, the lower the number, the thicker the cable.

Cable with a gauge of 16 may be used for short runs of less than ten feet. We do not recommend that you use cables with an AWG equivalent of 18 or higher, due to the power loss and degradation in performance that will occur.

Cables that are run inside walls should have the appropriate markings to indicate listing with UL, CSA or other appropriate testing agency standards. Questions about running cables inside walls should be referred to your installer or a licensed electrician who is familiar with the NEC and/or the applicable local building codes in your area.

When connecting wires to the speakers, be certain to observe proper polarity. Note that the positive (+) terminal of each speaker connection now carries a specific color code as noted on page 11. However, most speakers will still use a red terminal for the positive (+) connection. Connect the "negative" or "black" wire to the same terminal on both the receiver and the speaker.

NOTE: While most speaker manufacturers adhere to an industry convention of using black terminals for negative and red ones for positive, some manufacturers may vary from this configuration. To ensure proper phase and optimal performance, consult the identification plate on your speaker or the speaker's manual to verify polarity. If you do not know the polarity of your speaker, ask your dealer for advice before proceeding, or consult the speaker's manufacturer.

We also recommend that the length of cable used to connect speaker pairs be identical. For example, use the same length piece of cable to connect the front-left and front-right or surround-left and surround-right speakers, even if the speakers are a different distance from the AVR 520.

8. Connections to a subwoofer are normally made via a line-level audio connection from the **Subwoofer Output 5** to the line-level input of a subwoofer with a built-in amplifier. When a passive subwoofer is used, the connection first goes to a power amplifier, which will be connected to one or more subwoofer speakers. If you are using a powered subwoofer that does not have line-level input connections, follow the instructions furnished with the speaker for connection information.

9. If an external multi-channel audio source with 5.1 outputs such as an external digital processor/decoder, DVD-Audio or SACD player is used, connect the outputs of that device to the **6-Channel Direct Inputs 9**.

10. If an external multi-channel audio source with 7.1 outputs such as an external digital processor/decoder, DVD-Audio or SACD player is used, first connect the outputs of that device to both the 6 Channel Direct Inputs as noted above, and then connect the Surround Back Left and Surround Back Right output channels of the source device to the **8-Channel Direct Inputs 10**.

11. If a 7.1 channel source device is connected as noted in the item above, you must use an optional audio power amplifier for those channels. Connect the **SBL and SBR Preamp Outputs 63** to the inputs of the amplifier feeding those channels' speakers.

Video Equipment Connections

Video equipment is connected in the same manner as audio components. Again, the use of high-quality interconnect cables is recommended to preserve signal quality.

1. Connect a VCR's or other video source's audio and video Play/Out jacks to the **Video 1 or Video 2 In Jacks 27 30 34 36** on the rear panel. The Audio and Video Record/In jacks on the VCR should be connected to the **Video 1 or Video 2 Out Jacks 25 28 33 37** on the AVR 520.

2. Connect the analog audio and video outputs of a satellite receiver, cable TV converter or

Installation and Connections

television set or any other video source to the **Video 3** 29 35 jacks.

3. Connect the analog audio and video outputs of a DVD or laser disc player to the **DVD jacks** 6 13.

4. Connect the digital audio outputs of a DVD player, satellite receiver, cable box or HDTV converter to the appropriate **Optical** or **Coaxial Digital Inputs** 31 32 18 20.

5. Connect the **Video Monitor Output** 1 jacks on the receiver to the composite or S-Video input of your television monitor or video projector.

6. If your DVD player and monitor both have component video connections, connect the component outputs of the DVD player to the **DVD Component Video Inputs** 22. Note that even when component video connections are used, the audio connections should still be made to either the analog **DVD Audio Inputs** 6 or any of the **Optical** or **Coaxial Digital Input Jacks** 31 32.

7. If another component video device is available, connect it to the **Video 2 Component Video Input Jacks** 20. The audio connections for this device should be made to either the **Video 2 Audio Input Jacks** 34 or any of the **Optical** or **Coaxial Digital Input Jacks** 31 32.

8. If the component video inputs are used, connect the **Component Video Output** 21 to the component video inputs of your TV, projector or display device.

9. If you have a camcorder, video game or other audio/video device that is connected to the AVR on a temporary, rather than permanent basis, connect the audio, video and digital audio outputs of that device the **Front Panel Inputs** 18 20 21. A device connected here is selected as the Video 4 input, and the digital inputs must be assigned to the Video 4 input. (See page 20 for more information on input configuration.)

Video Connection Notes:

- When the component video jacks are used, the on-screen menus are not visible and you must switch to the standard composite or S-Video input on your TV to view them.
- The AVR 520 will accept either standard composite, S-Video or Y/Pr/Pb component

video signals. However, it will not convert composite or S signals to component video.

- Component or composite video signals may only be viewed in their native formats.

System and Power Connections

The AVR 520 is designed for flexible use with multiroom systems, external control components and power amplifiers.

Main Room Remote Control Extension

If the receiver is placed behind a solid or smoked glass cabinet door, the obstruction may prevent the remote sensor from receiving commands. In this event, an optional remote sensor may be used. Connect the output of the remote sensor to the **Remote IR Input** jack 24.

If other components are also prevented from receiving remote commands, only one sensor is needed. Simply use this unit's sensor or a remote eye by running a connection from the **Remote IR Output** jack 23 to the Remote IR Input jack on Harman Kardon or other compatible equipment.

Multiroom IR Link

The remote room IR receiver should be connected to the AVR 520 via standard coaxial cable. Plug the IR connection cable into the **Multiroom IR Input** jack 25 on the AVR 520's rear panel.

If other Harman Kardon compatible source equipment is part of the main room installation, the **Remote IR Output** jack 23 on the rear panel should be connected to the IR IN jack on source equipment. This will enable the remote room location to control source equipment functions.

NOTE: All remotely controlled components must be linked together in a "daisy chain". Connect the **IR OUT** jack of one unit to the **IR IN** of the next to establish this chain.

Multiroom Audio Connections

Depending on the distance from the AVR 520 to the remote room, two options are available for audio connection:

Option 1: Use high-quality, shielded audio interconnect cable from the AVR 520's location to the remote room. In the remote room, connect the interconnect cable to a stereo power amplifier. The amplifier will be connected to the room's speakers. At the AVR 520, plug the audio interconnect cables into the **Multiroom Output Jacks** 8 on the AVR 520's rear panel.

Option 2: Connect the **Multiroom Output Jacks** 8 on the AVR 520 to the inputs of an optional stereo power amplifier. Run high-quality speaker wire from the amplifier to the speakers in the remote room.

NOTE: In both options, you may connect an optional IR sensor in the remote room to the AVR 520 via an appropriate cable. Connect the sensor's cable to the **Multiroom IR Input** 25 on the AVR 520 and use the Zone II remote to control the room volume. Alternatively, you may install an optional volume control between the output of the amplifiers and the speakers.

AC Power Connections

This unit is equipped with two accessory AC outlets. They may be used to power accessory devices, but they should not be used with high-current draw equipment such as power amplifiers. The total power draw to each outlet may not exceed 100 watts.

The **Switched AC Accessory Outlet** 17 will receive power only when the unit is on. This is recommended for devices that have no power switch or a mechanical power switch that may be left in the "ON" position.

NOTE: Many audio and video products go into a Standby mode when they are used with switched outlets, and cannot be fully turned on using the outlet alone without a remote control command.

The **Unswitched AC Accessory Outlet** 18 will receive power as long as the unit is plugged into a powered AC outlet.

Finally, when all connections are complete, plug the power cord into a nonswitched 110-volt AC wall outlet. You're almost ready to enjoy the AVR 520!

System Configuration

When all audio, video and system connections have been made, there are a few configuration adjustments that must be made. A few minutes spent to correctly configure and calibrate the unit will greatly add to your listening experience.

Speaker Selection and Placement

The placement of speakers in a multichannel home-theater system can have a noticeable impact on the quality of sound reproduced.

No matter which type or brand of speakers is used, the same model or brand of speaker should be used for the left front, center and right front speakers. This creates a seamless front soundstage and eliminates the possibility of distracting sonic disturbances that occur when a sound moves across mismatched front-channel speakers.

Speaker Placement

Depending on the type of center-channel speaker in use and your viewing device, place the center speaker either directly above or below your TV, or in the center behind a perforated front projection screen.

Once the center channel speaker is installed, position the front left and front right speakers so that they are as far away from one another as the center-channel speaker is from the preferred listening position. Ideally, the front-channel speakers should be placed so that their tweeters are no more than 24" above or below the tweeter in the center-channel speaker.

Depending on the specifics of your room acoustics and the type of speakers in use, you may find that imaging is improved by moving the left front and right front speakers slightly forward of the center-channel speaker. If possible, adjust all front loudspeakers so that they are aimed at ear height when you are seated in the listening position.

Using these guidelines, you'll find that it takes some experimentation to find the correct location for the front speakers in your particular installation. Don't be afraid to move things around until the system sounds correct. Optimize your speakers so that audio transitions across the front of the room sound smooth, and that sounds from all speakers appear to arrive at the listening position at the same time (without delay from the center speaker compared to the left and right speakers).

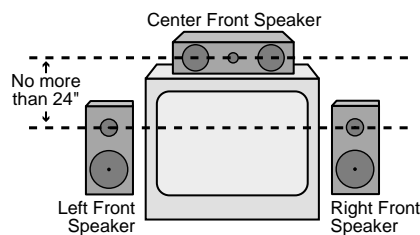

A) Front Channel Speaker Installation With Direct-View TV Sets or Rear-Screen Projectors

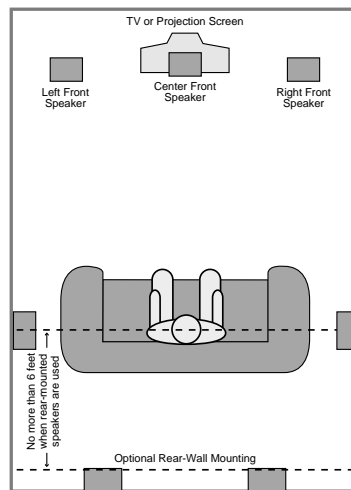

B) Rear speaker mounting is an alternate location for 5.1 systems. It is required for 7.1 operation.

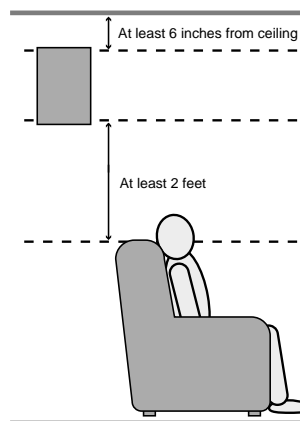

When the AVR 520 is used in 5.1-channel operation, the preferred location for surround speakers is on the side walls of the room, at or slightly behind the listening position. In a 7.1-channel system, both side surround and back surround speakers are required. The center of the speaker should face into the room. The speakers should be located so that the bottom of the cabinet is at least two feet higher than the listeners' ears when the listeners are seated in the desired area.

Rear surround speakers are required when a full 7.1-channel system is installed, and they may also be used in 5.1 channel as an alternative mounting position when it is not practical to place the main surround speakers on the sides of the room. Speakers may be placed on a rear wall, behind the listening position. As with the side speakers, rear surrounds should be located so that the bottom of the cabinet is at least two feet higher than the listeners' ears. The speakers should be no more than six feet behind the rear of the seating area.

Subwoofers produce nondirectional sound, so they may be placed almost anywhere in a room. Actual placement should be based on room size and shape and the type of subwoofer used. One method of finding the optimal location for a subwoofer is to begin by placing it in the front of the room, about six inches from a wall, or near the front corner of the room. Another method is to temporarily place the subwoofer at your normal listening position, and then walk around the room until you find a spot where the subwoofer sounds best. Place the subwoofer in that spot. You should also follow the instructions of the subwoofer's manufacturer, or you may wish to experiment with the best location for a subwoofer in your listening room.

System Configuration

System Setup

Once the speakers have been placed in the room and connected, the remaining steps in the setup process are to program the AVR 520's bass management system for the type of speakers used in your system, calibrate the output levels, and set the delay times used by the surround-sound processor.

You are now ready to power up the AVR 520 to begin these final adjustments.

1. Plug the **AC Power Cord** 19 into an unswitched AC outlet.
2. Press the **Main Power Switch** 1 in until it latches and the word "OFF" on the top of the switch disappears inside the front panel. Note that the **Power Indicator** 3 will turn amber, indicating that the unit is in the Standby mode.
3. Remove the protective plastic film from the front-panel lens. If left in place, the film may affect the performance of your remote control.
4. Install the three supplied AAA batteries in the remote as shown. Be certain to follow the (+) and (-) polarity indicators that are on the top of the battery compartment.

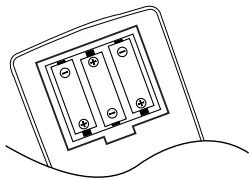

5. Turn the AVR 520 on either by pressing the **System Power Control** 2 on the front panel, or via the remote by pressing the **Power On Button** 4, the **AVR Selector** 6 or any of the **Input Selectors** 5 7 on the remote. The **Power Indicator** 3 will turn green to confirm that the unit is on, and the **Main Information Display** 29 will also light.

Using the On-Screen Display

When making the following adjustments, you may find it easier to use the AVR 520's on-screen display system. These easy-to-read displays give you a clear picture of the current status of the unit and make it easy to see which speaker, delay, input or digital selection you are making.

To view the on-screen menus, make certain you have made a connection from the **Video Monitor Out Jack** 1 on the rear panel to the composite or S-Video input of your TV or projector. In order to view the AVR 520's displays, the correct video source must be selected

on the video display. Note that the on-screen menus are not available when a component video display is in use.

IMPORTANT NOTE: When viewing the on-screen menus using a CRT-based projector, plasma display or any direct-view CRT monitor or television, it is important that they not be left on the screen for an extended period of time. The constant display of a static image such as these menus or video game images may cause the image to be permanently "burned into" the projection tubes, plasma screen or CRT. This type of damage is not covered by the AVR 520 warranty and may not be covered by the projector/TV set's warranty.

The AVR 520 has two on-screen display modes, "Semi-OSD" and "Full-OSD." When making configuration adjustments, it is recommended that the Full-OSD mode be used. This will place an option listing on the screen, making it easier to view the available options.

Making Configuration Adjustments

The full-OSD system is available by pressing the **OSD Button** 22. When this button is pressed, the **MASTER** menu (Figure 1) will appear, and adjustments are made from the individual menus.

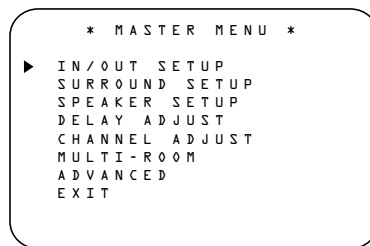

Figure 1

The semi-OSD system is also available, allowing you to make adjustments directly, by pressing the appropriate buttons on the front panel or remote control for the specific parameter to be adjusted. For example, to change the digital input for any of the sources, press the **Digital Select Button** 25 17 on the front panel or remote.

To use the full OSD menu system, press the **OSD Button** 22. When the menu is on the screen, press the **▲/▼ Buttons** 14 until the on-screen **▶** cursor is next to the item you wish to adjust, and then press the **Set Button** 16 to adjust that item. Note that the menus will remain on the screen for 20 seconds, and then they will "time-out" and disappear from the screen. The time-out may be increased to as much as 50 seconds by going to the

ADVANCED SELECT menu, and changing the item titled **FULL OSD TIME OUT**.

Note that when the full OSD system is in use, the menu selections are not shown in the **Main Information Display** 29 Y. When the full OSD menu system is used, OSD ON will appear in the **Main Information Display** Y and the **OSD Indicator** P will light to remind you that a video display must be used. When the semi-OSD system is used in conjunction with the discrete configuration buttons, the on-screen display will show a single line of text with the current menu selection. That selection will also be shown in the **Main Information Display** Y.

Setting the System Configuration Memory

The AVR 520 features an advanced memory system that enables you to establish different configurations for the speaker configuration, digital input, surround mode, delay times, crossover frequency and output levels for each input source. This flexibility enables you to custom-tailor the way in which you listen to each source and have the AVR 520 memorize those settings. This means, for example, that you may use different output levels or trims for different sources, or set different speaker configurations with the resultant changes to the bass management system. Once these settings are made, they will automatically be recalled whenever you select that input.

The factory default settings for the AVR 520 have all inputs except for DVD configured for an analog audio input except for the DVD input, where the **Coaxial Digital Input** 32 is the default. The default speaker settings are for "Large" speakers at the front left/right, "Small" at all other positions, and for the Subwoofer set as being on. However, once the DSP processing system is used for the first time for any input, the speaker settings will automatically default to "Small" at all positions with the subwoofer set to "LFE." The default setting for the surround modes is "Surround Off," or two-channel stereo, although Dolby Digital or DTS will automatically be selected as appropriate when a source with digital encoding is in use.

Before using the unit, you will probably want to change the settings for most inputs so that they are properly configured to reflect the use of digital or analog inputs, the type of speakers installed and the surround mode specifics of your home theater system. Remember that

System Configuration

since the AVR 520 memorizes the settings for each input individually, you will need to make these adjustments for each input used. However, once they are made, further adjustment is only required when system components are changed.

To make this process as quick and as easy as possible, we suggest that you use the full-OSD system with the on-screen menus, and step through each input. Once you have completed the settings for the first input, many settings may be duplicated for the remaining inputs. It is also a good idea to set the configuration data in the order these items are listed in the **MASTER** menu, as some settings require a specific entry in a prior menu item. Remember that once the settings are made for one input, they must be made for all other input sources in your system.

Input Setup

The first step in configuring the AVR 520 is to configure each input. When using the full-OSD system to make the setup adjustments, press the **OSD Button 22** once so that the **MASTER** menu (Figure 1) appears. Note that the ► cursor will be next to the **IN/OUT SETUP** line. Press the **Set Button 16** to enter the menu and the **IN/OUT SETUP** menu (Figure 2) will appear on the screen. Press the ◀▶ **Buttons 15 37** until the desired input name appears in the highlighted video, as well as being indicated in the front panel **Input Indicators 22** by the green LED next to the desired input name. If the input will use the standard left/right analog inputs, no further adjustment is needed.

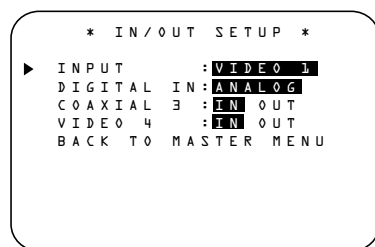

Figure 2

If you wish to associate one of the digital inputs with the selected input source, press the ▼ **Button 14** on the remote while the **IN/OUT SETUP** menu (Figure 2) is on the screen, and note that the on-screen cursor will drop down to the **DIGITAL IN** line. Press the ◀▶ **Buttons 15 37** until the name of the desired digital input appears. To return to the analog input, press the buttons

until the word **ANALOG** appears. When the correct input source appears, press the ▼ **button 14** once so that the ► cursor appears next to **BACK TO MASTER MENU**, and press the **Set Button 16**.

To change the digital input at any time using the discrete function buttons and the semi-OSD system, press the **Digital Input Select Button 24 17** on the front panel or the remote. Within five seconds, make your input selection using the **Selector** buttons on the front panel **5** or the ▲/▼ **14 Buttons** on the remote until the desired digital or analog input is shown in the **Main Information Display 11** and in the lower third of the video display connected to the AVR 520. Press the **Set Button 16** to enter the new digital input assignment.

An exclusive Harman Kardon feature is the ability to switch front panel coaxial digital audio and analog audio/video jacks from their normal use as inputs to output connections so that portable recording devices may easily be connected. On the AVR 520, the **Digital Coax 3 Jack 20** is normally an input, but this may also be switched to a digital output for use with CD-R/RW decks, MD recorders or other A/V recorders. To change the jack to an output, press the ▲/▼ **Buttons 14** while the **IN/OUT SETUP** menu is on the screen until the ► cursor is next to **COAXIAL 3**. Then press the ◀▶ **Buttons 15 37** so that the word **OUT** is highlighted. Note that the **Input/Output Status Indicator 19** will turn red, indicating that the jack is now a record output.

NOTE: A signal will be sent to this jack only when the input selected for use by the AVR 520 is digital. Digital signals will be passed through regardless of their format, and which digital input (optical or coax) they are fed from. However, analog signals are not converted to digital, and the format of the signal (e.g., PCM, Dolby Digital or DTS) may not be changed.

Selection of the front panel jacks as an output will remain effective as long as the AVR 520 is on. Once the unit is turned off, the jacks will revert to their normal use as an input when the unit is turned on again.

The front panel analog **Video 4 Inputs 21** are normally set as an input for use with camcorders, video games and other portable audio/video products, but they may be switched to an output for connection to portable audio/video recorders. To temporarily switch

them to outputs, you must first be at the **IN/OUT SETUP** menu. Press the ▼ **Button 14** until the on-screen ► cursor is pointing to the **VIDEO 4** line. Press the ► **Button 37** so that the word **OUT** is highlighted. Note that the **Input/Output Status Indicator 19** between the S and Composite video jacks will turn red, indicating that the analog Video 4 jacks are now record outputs.

Surround Setup

Once the basic input setup has been completed, the next step is to set the surround mode you wish to use with an input. Since surround modes are a matter of personal taste, feel free to select any mode you wish – you may change it later. However, to make it easier to establish the initial parameters for the AVR 520, it is best to select Dolby Pro Logic II or Logic 7 for most analog inputs and Dolby Digital for inputs connected to digital sources. In the case of inputs such as a CD Player, Tape Deck or Tuner, you may wish to set the mode to Stereo (“Surround off”) as they are not typically used with multi-channel program material, where it is unlikely that surround-encoded material will be used. Alternatively, the Logic 7 Music mode is a good choice for stereo-only source material.

It is easiest to complete the surround setup using the full-OSD on-screen menus. From the **MASTER** menu (Figure 1), press the ▲/▼ **Buttons 14** until the ► cursor is next to the **SURROUND SELECT** menu. Press the **Set Button 16** so that the **SURROUND SELECT** menu (Figure 3) is on the screen.

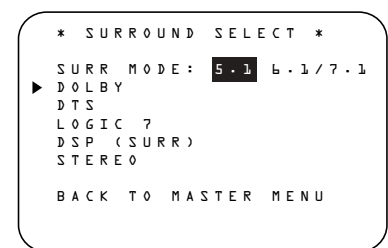

Figure 3

The first line on the **SURROUND SELECT** menu allows you to configure the AVR for either standard 5.1 or advanced 6.1/7.1 operation. With the on-screen ► cursor at the **SURR MODE** line, press the **Set Button 16** and then press the ◀ or ▶ **Buttons 15 37** so that **5.1** is highlighted if you have five surround speakers installed, or **6.1/7.1** if you have one or two speakers connected to the **Surround Back Preamp Outputs 33** through optional, external power amplifiers.

System Configuration

Making this selection will set the surround mode options for the AVR so that only the correct modes for the number of speakers in your specific system will be available. Should you change your system and add additional speakers at a later date, it is important to change this setting so that advanced surround modes such as Logic 7/7.1 and DTS-ES 6.1 Discrete and Matrix will be available.

When the desired selection is made, press the **Set Button 16** to continue with the setup and configuration.

Once the setting is made for 5.1 or 6.1/7.1 operation, the default surround mode for an input should be set. Each of the remaining five lines on the menu (Figure 3) contains the various surround mode categories, and within those menus you may choose one of the sub-modes. Note that the list of specific sub-modes in some categories will vary according to whether 5.1 or 6.1/7.1 operation is chosen. In addition, some of the modes available in the AVR 520 will not appear unless a digital source is selected and playing the correct bitstream.

To select the mode that will be used as the initial default for an input, first press the **▲/▼ Buttons 14** until the on-screen cursor is next to the desired mode's master category name. Next, press the **Set Button 16** to view the sub-menu. Press the **◀/▶ Buttons 15 37** to scroll through the available choices, and then press the **▼ Button 14** so that the cursor is next to **BACK TO MASTER MENU** to continue the setup process.

On the **Dolby** menu (Figure 4), the selection choices include Dolby Digital, Dolby Pro Logic II Music, Dolby Pro Logic II Cinema, Dolby Pro Logic II Emulation and Dolby 3 Stereo. A complete explanation of these modes is found on Page 26. Note that when the Dolby Digital mode is selected there are additional settings available for the Night mode.

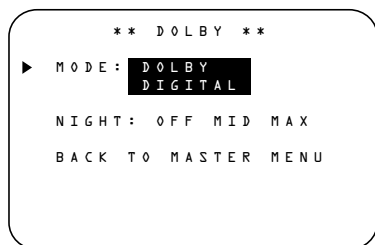

Figure 4

The Night mode is a feature of Dolby Digital that uses special processing to preserve the dynamic range and full intelligibility of a movie sound track while reducing the peak level. This prevents abruptly loud transitions from disturbing others, without reducing the sonic impact of a digital source. Note that the Night mode is only available when specially encoded Dolby Digital signals are played.

To adjust the Night mode setting for an input from the menu, make certain that the **▶** cursor is on the **NIGHT** line of the **DOLBY** menu. Next, press **◀/▶ Buttons 15 37** to choose between the following settings, as they appear in the on-screen display:

OFF: When **OFF** is highlighted, the Night mode will not function.

MID: When **MID** is highlighted, a mild compression will be applied.

MAX: When **MAX** is highlighted, a more severe compression algorithm will be applied.

We recommend that you select the **MID** setting as a starting point and change to the **MAX** setting later, if desired.

Note that the Night mode may be adjusted directly any time that a Dolby Digital source is playing by pressing the **Night Button 12**. When the button is pressed, the phrase **D-RANGE** will appear in the lower third of the video screen and in the **Main Information Display Y**. Press the **▲/▼ Button 14** within three seconds to select the desired setting.

When all settings for the surround setup have been made, press the **▲/▼ Buttons 14** so that the **▶** cursor is next to **BACK TO MASTER MENU**, and press the **Set Button 16** to return to the **Master** menu.

On the **DTS** menu, the selection choices made with the **◀/▶ Buttons 15 37** on the remote are determined by a combination of the type of DTS program material in use and whether the 5.1 or 6.1/7.1 speaker output configuration is in use. When either of the speaker configurations is in use, you may select either the Neo:6 Music or Neo:6 Cinema mode when an analog source is playing to deliver an enhanced 5.1-channel sound field.

When the 5.1 configuration is in use the AVR will automatically select the 5.1 version of DTS

processing when a DTS data stream is selected. When the 6.1/7.1 mode is selected, the DTS-ES Discrete mode will automatically be activated when a DTS source with the ES Discrete "flag" is in use. In these cases the **DTS-ES Mode Indicator D** will light. When a non-ES DTS disc is in use, you may select the DTS-ES Matrix mode through this menu to create a full eight-speaker surround mode. See page 26 for a complete explanation of the DTS modes.

On the **Logic 7** menu, the selection choices made with the **◀/▶ Buttons 15 37** on the remote are determined by whether the 5.1 or 6.1/7.1 speaker output configuration is in use. In either case, the selection of a Logic 7 mode enables Harman Kardon's exclusive Logic 7 processing to create fully enveloping, multichannel surround from either two-channel Stereo or Matrix-encoded programming such as VHS cassettes, laser discs or television broadcasts produced with Dolby surround.

In the 5.1 configuration you may select the Logic 7/5.1 Music, Cinema or Enhanced modes. They work best with two-channel music, surround-encoded programs or standard two-channel programming of any type, respectively. When the 6.1/7.1 mode is selected, only the Music and Cinema modes are available, and the output will be in a full eight-channel sound field. Note that the Logic 7 modes are not available when either Dolby Digital or DTS Digital soundtracks are in use. See pages 26 and 27 for a complete explanation of the DSP Surround modes.

On the **DSP (SURR)** menu, the selection choices made with the **◀/▶ Buttons 15 37** on the remote select from one of the DSP surround modes that are designed for use with two-channel stereo programs to create a variety of sound field presentations. The choices available are Hall 1, Hall 2, Theater, VMaX Near and VMaX Far. The Hall and Theater modes are designed for multichannel installations, while the two VMaX modes are optimized for use in delivering a full surround field when only the front left and front right speakers are installed. See pages 26 and 27 for a complete explanation of the DSP surround modes.

On the **STEREO** menu, the selection choices made with the **◀/▶ Buttons 15 37** on the remote may either turn the surround processing off for a traditional two-channel stereo presentation, or select **5 Stereo** or **7 Stereo** depending on whether the 5.1 or 6.1/7.1 output is in use. The latter modes feed a two-chan-

System Configuration

nel presentation to all speakers, regardless of the number of speakers in use. See page 27 for a complete explanation of the 5 Stereo and 7 Stereo modes. After the selections are made on the Dolby, DTS, Logic 7, DSP (Surround) or stereo menus, press the ▲/▼ Buttons 14 so that the cursor moves to the **BACK TO MASTER MENU** line and press the **Set Button 16**.

Speaker Setup

This menu tells the AVR 520 which type of speakers are in use. This is important as it adjusts the settings that determine which speakers receive low-frequency (bass) information. For each of these settings use the **LARGE** setting if the speakers for a particular position are traditional full-range loudspeakers that are capable of reproducing sounds below 100Hz. Use the **SMALL** setting for smaller, frequency-limited satellite speakers that do not reproduce sounds below 100Hz. Note that when "small" speakers are used, a subwoofer is required to reproduce low-frequency sounds. Remember that the "large" and "small" descriptions do not refer to the actual physical size of the speakers, but to their ability to reproduce low-frequency sounds. If you are in doubt as to which category describes your speakers, consult the specifications in the speakers' owner's manual, or ask your dealer.

After the selections are made on the Dolby DTS, Logic 7 DSP (Surr) or stereo menus, press ▲/▼ Buttons 14, so that the cursor moves to the **BACK TO MASTER MENU** line and press the **Set Button 16**.

It is easiest to enter the proper settings for the speaker setup through the **SPEAKER SETUP** menu (Figure 5). If that menu is not already on your screen from the prior adjustments, press the **OSD Button 22** to bring up the **MASTER MENU** (Figure 1), and then press the ▼ Button 14 twice so that the cursor is on the **SPEAKER SETUP** line. At this point, press the **Set Button 16** to bring up the **SPEAKER SETUP** menu (Figure 5).

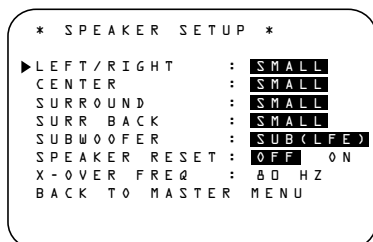

Figure 5

When the **SPEAKER SETUP** menu first appears, the on-screen cursor ▶ will be at the top of the list of speaker positions, pointing toward the **LEFT/RIGHT** line, which sets the configuration for the front left and right speakers. If you wish to make a change to the front speakers' configuration, press the ◀▶ Buttons 15 37 so that either **LARGE** or **SMALL** appears, matching the appropriate description from the definitions shown above.

When **SMALL** is selected, low-frequency sounds will be sent only to the subwoofer output. If you choose this option and there is no subwoofer connected, you will not hear any low-frequency sounds from the front channels.

When **LARGE** is selected, a full-range output will be sent to the front left and front right outputs. Depending on the choice made in the **SUBWOOFER** line in this menu, bass information may also be directed to the front left/right speakers, a subwoofer or both.

When you have completed your selection for the front channel, press the ▼ Button 14 on the remote to move the cursor to **CENTER**.

Press the ◀▶ Buttons 15 37 on the remote to select the option that best describes your system, based on the speaker definitions shown below.

When **SMALL** is selected, low-frequency center channel sounds will be sent only to the subwoofer output. If you choose this option and there is no subwoofer connected, you will not hear low-frequency sounds from the center channel speaker.

When **LARGE** is selected, a full-range output will be sent to the center speaker output, and NO center channel signal will be sent to the subwoofer output.

NOTE: If you choose Logic 7 as the surround mode for the particular input source for which you are configuring your speakers, the AVR 520 will not make the **LARGE** option available for the center speaker. This is due to the requirements of Logic 7 processing, and does not indicate a problem with your receiver.

When **NONE** is selected, no signals will be sent to the center-channel output. The receiver will operate in a "phantom" center channel mode and center-channel information will be sent to the left and right front channel outputs. When only front left and right speak-

ers are used, with no center or surround speakers, VMAx is a good alternative mode.

When you have completed your selection for the center channel, press the ▼ Button 14 on the remote to move the cursor to **SURROUND**.

Press the ◀▶ Buttons 15 37 on the remote to select the option that best describes the surround speakers in your system based on the speaker definitions shown on this page.

When **SMALL** is selected, low-frequency surround channel sounds will be sent to the subwoofer output only. If you choose this option and there is no subwoofer connected, you will not hear any low frequency sounds from the surround speakers.

When **LARGE** is selected, a full-range output will be sent to the surround channel outputs, and NO surround channel signals will be sent to the subwoofer output.

When **NONE** is selected, surround-sound information will be split between the front left and front right outputs. For optimal performance when no surround speakers are in use, the Dolby 3 Stereo mode should be used.

If the 6.1/7.1 configuration has been selected in the **SURROUND SELECT** menu, an additional configuration line is available on the menu screen to set the speaker type for the speakers connected to the **Surround Back Preamp Outputs 38** through an optional, external power amplifier. The choices and procedure for configuring these speakers are identical to those shown above for the main surround speakers.

When you have completed your selection for the surround channels, press the ▼ Button 14 on the remote to move the cursor to **SUBWOOFER**.

Press the ◀▶ Buttons 15 37 on the remote to select the option that best describes your system.

The choices available for the subwoofer position will depend on the settings for the other speakers, particularly the front left/right positions.

If the front left/right speakers are set to **SMALL**, the subwoofer will automatically be set to **SUB**, which is the "on" position.

System Configuration

If the front left/right speakers are set to **LARGE**, three options are available:

- If no subwoofer is connected to the AVR 520, press the **◀▶ Buttons 15 37** on the remote so that **NONE** appears in the on-screen menu. When this option is selected, all bass information will be routed to the front left/right "main" speakers.
- If a subwoofer is connected to the AVR 520, you have the option to have the front left/right "main" speakers reproduce bass frequencies at all times, and have the subwoofer operate only when the AVR 520 is being used with a digital source that contains a dedicated Low Frequency Effects, or LFE soundtrack. This allows you to use both your main and subwoofer speakers to take advantage of the special bass created for certain movies. Press **◀▶ Buttons 15 37** on the remote so that **SUB (LFE)** appears in the on-screen menu.
- If a subwoofer is connected and you wish to use it for bass reproduction in conjunction with the main front left/right speakers, regardless of the type of program source or Surround mode you are listening to, press the **◀▶ Buttons 15 37** on the remote so that **SUB LFE+L/R** appears in the on-screen menu. When this option is selected, a full-range signal will be sent to the front left/right "main" speakers, and the subwoofer will receive the bass frequencies under frequency selected in the next option setting on this menu, as described below.

When you have completed your selection for the subwoofer, press the **▼ button 14** on the remote to change the cursor to **SUB X-OVER FREQ**. The subwoofer crossover setting may only be adjusted using the on-screen display system.

At this line, you will select the frequency at which bass information is directed to the **Subwoofer Output 5**. The choices available will depend on the setting made previously for the front left/right speakers. When making these selections, choose the crossover frequency that is closest to that of your front left/right speakers, or the upper frequency limit of your subwoofer. This figure is normally printed in the owner's manual or data sheet for the speakers; or consult the speaker's manufacturer.

- When the front speakers have been set to **LARGE**, the crossover choices are

40 Hz or **60 Hz** to match the typical crossover points of full range speakers. Choose the option that is closest to your speakers' design.

- When the front speakers have been set to **SMALL**, the crossover choices are **80 Hz** or **100 Hz** to match the typical crossover points of the smaller speakers used in satellite speaker systems. Choose the option that is closest to your speakers' design.

When all speaker selections have been made, press the **▼ Button 14** and then the **Set Button 16** to return to the **Master** menu.

Delay Settings

If Dolby Digital or Dolby Pro Logic is selected as the surround mode for an input, you may need to adjust the delay time setting. Note that the delay time is not adjustable for any other modes.

Due to the different distances between the listening position for the front-channel speakers and the surround speakers, the amount of time it takes for sound to reach your ears from the front versus surround speakers differs. You may compensate for this difference through the use of the delay settings to adjust the timing for the speaker placement and acoustic conditions in your listening room or home theater.

The factory setting is appropriate for most rooms, but some installations create an uncommon distance between the front and surround speakers that may cause the arrival of front-channel sounds to become disconnected from surround-channel sounds.

To resynchronize the front and surround channels, follow these steps:

1. Measure the distance from the listening position to the front speakers.
2. Measure the distance from the listening position to the surround speakers.
3. Subtract the distance to the surround speakers from the distance to the front speakers.
 - a. When setting the delay time for the Dolby Digital surround modes, the optimal delay time is the result of that subtraction. For example, if the front speakers are ten feet away and the surround speakers are five feet away, the optimal

delay time is figured as $10-5=5$. Thus, in this example, the delay time for Dolby Digital should be set at five milliseconds.

- b. When setting the delay time for the Pro Logic mode, take the result of the subtraction and add 15 to obtain the optimal delay time. For example, if the front speakers are ten feet away and the surround speakers are five feet away, the optimal delay time is figured as $10-5+15=20$. Thus, in this example, the Pro Logic delay should be set at twenty milliseconds.

NOTE: The DTS, Logic 7 and DSP modes use a fixed, nonadjustable delay time.

The Dolby Digital mode also includes a separate setting for the Center Channel Delay mode, since the discrete nature of these signals makes the location of the center-channel speaker more critical. To calculate the delay for the center channel, measure the distance from the preferred listening position in the center of the room to both the center-channel speaker and either the left or right speaker.

If the distances are equal, no further adjustment is required and the center delay should be set to zero. If the distance to the front speakers is greater than the distance to the center speaker, you may wish to reposition the speakers by moving the front left and front right speakers closer to the listening position or the center speaker further away from the listening position.

If repositioning of the speakers is not possible, adjust the center delay time, adding one millisecond of center-channel delay for every foot closer to the listening position the center speaker is than the front speakers. For example, if the front left and front right speakers are each 10 feet from the listening position and the center-channel speaker is 8 feet away, the delay is figured as $10-8=2$, suggesting an optimal center delay of 2 milliseconds.

To set the delay time for a specific input, the **DELAY ADJUST** menu (Figure 6) should be visible on your on-screen display. If the system is not already at that point, press the **OSD Button 22** to bring up the **MASTER MENU**, press the **▶ Button 14** three times or until the on-screen **▶** cursor is pointing at the **DELAY ADJUST** line. Press the **Set Button 16** to call up the menu.

System Configuration

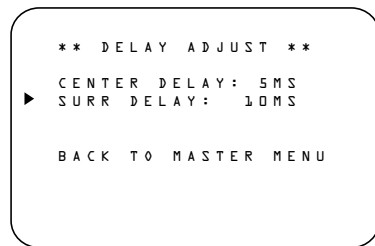

Figure 6

If the Dolby Digital mode is selected, the **CENTER DELAY** line is where the first adjustment is made. In that case, press the **Left/Right Buttons 15 37** until the number calculated using the formula shown above appears in the display. When the **CENTER DELAY** is entered, press the **Down Button 14** once to move to the next line.

When the **CENTER DELAY** is set, or if the Dolby Pro Logic II mode is selected, the **Right** cursor will be at the **SURR DELAY** line so that the delay for the surround speakers may be set. Press the **Left/Right Buttons 15 37** until the number calculated using the formula shown above appears in the display. When the delay settings are complete, press the **Down Button 14** once so that the cursor is next to the **BACK TO MASTER MENU** line and press the **Set Button 16** to return to the **MASTER** menu.

Output Level Adjustment

Output level adjustment is a key part of the configuration of any surround-sound product. It is particularly important for a digital receiver such as the AVR 520, as correct outputs ensure that you hear sound tracks with the proper directionality and intensity.

IMPORTANT NOTE: Listeners are often confused about the operation of the surround channels. While some assume that sound should always be coming from each speaker, most of the time there will be little or no sound in the surround channels. This is because they are only used when a movie director or sound mixer specifically places sound there to create ambience, a special effect or to continue action from the front of the room to the rear. When the output levels are properly set, it is normal for surround speakers to operate only occasionally. Artificially increasing the volume to the rear speakers may destroy the illusion of an enveloping sound field that duplicates the way you hear sound in a movie theater or concert hall.

Before beginning the output level adjustment process, make certain that all speaker connections have been properly made. The system volume should be set to the level that you will use during a typical listening session. Finally, make certain that the **Balance Control 23** is set to the center “12 o’clock” position.

Using EzSet

Harman Kardon’s exclusive EzSet remote makes it possible to quickly and accurately set the AVR 520’s output levels without the use of a sound pressure meter, although manual adjustment is also available. However, for the easiest set-up, follow these steps while seated in the listening position that will be used most often:

1. Make certain that all speaker positions have been properly configured for their “large” or “small” settings (as outlined above) and turn off the OSD system if it is in use.
2. Adjust the volume so that it is at **-15**, as shown in the on-screen display or **Main Information Display Y**.
3. Hold the remote in front of you at arm’s length, being sure not to cover the **EzSet Sensor Microphone 44** at the top of the remote.
4. Press and hold the **SPL Indicator Select Button 41** for three seconds. Release it when the **Program/SPL Indicator 3** stops flashing and remains lit. Within five seconds, press the **5 Button 18** on the remote if your system is configured for 5.1 operation with standard speakers or the **7 Button 18** on the remote if your system is configured for 6.1/7.1 operation with a full speaker complement including rear surround speakers. Once the correct channel configuration button has been pressed the test noise will be heard from the front left speaker.
5. At this point, EzSet will take over, adjusting the output level of each channel so that when the process is complete all levels will be equal and at the set reference point. This process may take a few minutes, depending on the extent of adjustment required.
6. During the adjustment, you will see the location of the channel position being adjusted appear in the on-screen display (if connected) in the **Main Information Display Y**, alternating with a readout of the output setting, rela-

tive to the reference volume level, and in the **Speaker/Channel Input Indicators Q** where the letters for the channel being adjusted will flash to indicate from which channel the test tone should be heard. As the adjustment proceeds, a few things will happen simultaneously:

- The channel position being adjusted will flash in the **Speaker/Channel Input Indicators Q**. If the test noise is heard from a channel other than the one shown in the Indicator, there is an error in the speaker connections. If this is the case, press the **Test Button 9** TWICE to stop the adjustment. Then, turn the unit off and verify that all speakers are connected to the proper **Outputs 14 15 16** and that any connections made to rear surround speakers powered by optional amplifiers through the **Preamp Outputs 38** are correct.
 - As the individual channels are set, the channel name and the adjustment offset will appear in the on-screen display (if connected) and the **Main Information Display Y**. While the level is changing, the **Program/SPL Indicator 3** will change colors to reflect the output level in relation to the reference. A red indication shows that the level is too high, while an amber indication shows that the level is too low. When the indicator is green, the level is correct, and the test noise will move to the next channel.
 - While adjustments are being made, the red LED under the **AVR Selector 6** will flash. This is normal, and indicates that EzSet is operating.
7. After the test noise has circulated once through each channel, it will send the tone to each channel once again, to verify the settings.
 8. After two complete circulations of the tone, the levels are set. The **Program/SPL Indicator 3** will remain green at each channel. Upon completion of the second circulation, the **Program/SPL Indicator 3** will flash green twice and then go out. The tone will stop and the AVR 520 will return to normal operation.

If you find that the output levels chosen by EzSet are either uncomfortably low or high, you may repeat the procedure. Return to Step 2 and adjust the master volume either slightly higher or lower to accommodate your particular room layout and your tastes. You may repeat this pro-

System Configuration

cedure as many times as necessary to achieve a desired result. In order to prevent possible damage to your hearing or your equipment, we emphasize that you should avoid setting the master volume above 0dB.

Manual Output Level Adjustment

Output levels may also be adjusted manually, either to set them to a specific level with an SPL meter, or to make fine tuning adjustments to the levels obtained using the EzSet remote.

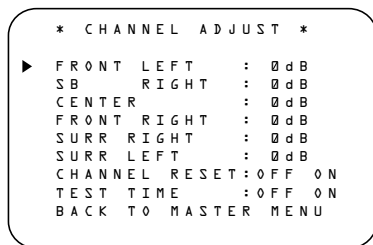

Figure 7

Manual output level adjustment is most easily done through the **CHANNEL ADJUST** menu (Figure 7). If you are already at the main menu, press the **▼ Button 14** until the on-screen **▶** cursor is next to the **CHANNEL ADJUST** line. If you are not at the main menu, press the **OSD Button 22** to bring up the **MASTER MENU** (Figure 1), and then press the **▼ Button 14** four times so that the on-screen **▶** cursor is next to the **CHANNEL ADJUST** line. Press the **Set Button 16** to bring the **CHANNEL ADJUST** menu (Figure 7) to the screen.

As soon as the new menu appears, you will hear a test noise circulate from speaker to speaker in a clockwise direction around the room. The test noise will play for two seconds in each speaker before circulating, and a blinking on-screen cursor will appear next to the name of each speaker location when the sound is at that speaker.

NOTE: Remember to verify that the speakers have been properly connected. As the test noise circulates, listen to make certain that the sound comes from the speaker position shown in the **Main Information Display Y**. If the sound from a speaker location does NOT match the position indicated in the display, turn the AVR 520 off using the **Main Power Switch 1** and check the speaker wiring or connections to external power amplifiers to make certain that each speaker is connected to the correct output terminal.

After checking for speaker placement, let the test noise circulate again, and listen to see which channels sound louder than the others. Using the front left speaker as a reference, press the **◀▶ Buttons 15 37** on the remote to bring all speakers to the same volume level. When one of the **◀▶** buttons is pushed, the test noise circulation will pause on the channel being adjusted to give you time to make the adjustment. When you release the button, the circulation will resume after five seconds.

Continue to adjust the individual channels until the volume level sounds the same from each speaker. Note that adjustments should be made with the **◀▶ Buttons 15 37** on the remote only, NOT the main volume controls. If you are using a sound-pressure level (SPL) meter for precise level adjustment, set the volume so that the meter reads 75dB, C-Weighting Slow.

You may also adjust the output levels manually while using the level indication feature of the EzSet remote. To activate the sensor and indicator, simply press and release the **Program/SPL Indicator Button 3** on the remote while the test tone is circulating. The **Program/SPL Indicator 3** will change color to indicate the level. Adjust the level using the **◀▶ Buttons 15 37** until the LED lights green for all channels. When it is red, the level is too high; when it is amber, the level is too low. Press the **SPL Indicator Select 3** button when you are finished to turn the sensor and Indicator off.

NOTE: The subwoofer output level is not adjustable using the test tone. To change the subwoofer level, follow the steps for Output Level Trim Adjustment on page 32.

When all channels have an equal volume level, the adjustment is complete. To exit this menu, press the **▲/▼ Buttons 14** until the on-screen **▶** cursor is next to the **BACK TO MASTER MENU** line, and then press the **Set Button 16** to return to the **MASTER** menu.

The output levels may also be adjusted at any time using the remote control and semi-OSD system. To adjust the output levels in this fashion, press the **Test Button 9**. As soon as the button is pressed, the test tone will begin to circulate as indicated earlier. The correct channel from which the test noise should be

heard will be shown in the lower third of the video screen and in the **Main Information Display Y**. While the test noise is circulating, the proper channel position will also be indicated in the **Speaker/Channel Input Indicators Q** by a blinking letter within the correct channel.

To adjust the output level, press the **◀▶ Buttons 15 37** until the desired level is shown in the display or on screen. Once the buttons are released, the test noise will begin to circulate again in five seconds.

When all channels have the same output level, press the **Test Tone Selector 9** button again to complete the process.

NOTE: Output level adjustment is not available for the VMAx or Surround Off mode.

Additional Input Adjustments

After one input has been adjusted for Surround mode, digital input (if any), speaker type, and output levels, go back to the **IN/OUT SETUP** line on the **MASTER MENU** and enter the settings for each input that you will use. In most cases, only the digital input and surround mode will be different from one input to the next, while the speaker type, crossover frequency, Night mode and output level settings will usually be the same and may be quickly entered by entering the same data used for the original input.

Once the settings outlined on the previous pages have been made, the AVR 520 is ready for operation. While there are some additional settings to be made, these are best done after you have had an opportunity to listen to a variety of sources and different kinds of program material. These advanced settings are described on pages 34 to 35 of this manual. In addition, any of the settings made in the initial configuration of the unit may be changed at any time. As you add new or different sources or speakers, or if you wish to change a setting to better reflect your listening taste, simply follow the instructions for changing the settings for that parameter as shown in this section.

Having completed the setup and configuration process for your AVR 520, you are about to experience the finest in music and home-theater listening. Enjoy!

Operation

Surround Mode Chart

MODE	FEATURES	DELAY TIME RANGE
DOLBY DIGITAL	Available only with digital input sources encoded with Dolby Digital data. It provides up to five separate main audio channels and a special dedicated Low-Frequency Effects channel.	Center: 0 ms – 5 ms Surround: 0 ms – 15 ms
DTS 5.1	When the speaker configuration is set for 5.1-channel operation, the DTS 5.1 mode is available when DVD, audio-only music or laser discs encoded with DTS data are played. DTS 5.1 provides up to five separate main audio channels and a special dedicated low-frequency channel.	Delay time not adjustable
DTS-ES 6.1 Matrix DTS-ES 6.1 Discrete	When the speaker configuration is set for 6.1/7.1 operation, playback of a DTS-encoded program source will automatically trigger the selection of one of the two DTS-ES modes. Newer discs with special DTS-ES discrete encoding will be decoded to provide six discrete, full-bandwidth channels plus a separate low-frequency channel. All other DTS discs will be decoded using the DTS-ES Matrix mode, which creates a 6.1-channel sound field from the original 5.1-channel soundtrack.	Delay time not adjustable
DOLBY PRO LOGIC II MOVIE MUSIC EMULATION	Dolby Pro Logic II is the latest version of Dolby Laboratory's benchmark surround technology that decodes full-range, discrete left, center right, right surround and left surround channels from either matrix surround encoded programs and conventional stereo sources when an analog input is in use. The Dolby Pro Logic II Movie mode is optimized for movie soundtracks, while the Pro Logic II Music mode should be used with musical selections. The Pro Logic II Emulation mode re-creates original Pro Logic processing for those who prefer that presentation.	15 ms – 30 ms
Logic 7 Cinema Logic 7 Music Logic 7 Enhance	Exclusive to Harman Kardon for AV receivers, Logic 7 is an advanced mode that extracts the maximum surround information from either surround-encoded programs or conventional stereo material. Depending on the number of speakers in use and the selection made in the SURROUND SELECT menu, the "5.1" versions of Logic 7 modes are available when the 5.1 option is chosen, while the "7.1" versions of Logic 7 produce a full sound field presentation, including back surround speakers when the "6.1/7.1" option is chosen. The Logic 7 C (or Cinema) mode should be used with any source that contains Dolby Surround or similar matrix encoding. Logic 7 C delivers increased center-channel intelligibility, and more accurate placement of sounds with fades and pans that are much smoother and more realistic than with other decoding techniques. The Logic 7 M or Music mode should be used with analog or PCM stereo sources. Logic 7 M enhances the listening experience by presenting a wider front soundstage and greater rear ambience. Both Logic 7 modes also direct low-frequency information to the subwoofer (if installed and configured) to deliver maximum bass impact. The Logic 7 E (or Enhance) mode, available only when the 5.1 option is chosen, is an extension of the Logic 7 modes that is primarily used with musical programs. Logic 7 adds additional bass enhancement that circulates low frequencies in the 40Hz to 120Hz range to the front and surround speakers to deliver a less localized soundstage that appears broader and wider than when the subwoofer is the sole source of bass energy.	Delay time not adjustable
DTS Neo:6 Cinema DTS Neo:6 Music	These two modes are available when any analog source is playing to create a six-channel surround presentation from conventional Matrix-encoded and traditional Stereo sources. Select the Cinema version of Neo:6 when a program with any type of analog Matrix surround encoding is present. Select the Music version of Neo:6 for optimal processing when a nonencoded, two-channel stereo program is being played.	Delay time not adjustable
DOLBY 3 STEREO	Uses the information contained in a surround-encoded or two-channel stereo program to create center-channel information. In addition, the information that is normally sent to the rear-channel surround speakers is carefully mixed in with the front-left and front-right channels for increased realism. Use this mode when you have a center-channel speaker but no surround speakers.	No surround channels
THEATER	The THEATER mode creates a sound field that resembles the acoustic feeling of a standard live performance theater.	Delay time not adjustable

Operation

MODE	FEATURES	DELAY TIME RANGE
HALL 1 HALL 2	The two Hall modes create sound fields that resemble a small (HALL1) or medium sized (HALL 2) concert hall.	Delay time not adjustable
VMAx Near VMAx Far	When only the two front-channel loudspeakers are used, Harman's patented VMAx mode delivers a three-dimensional sound space with the illusion of "phantom speakers" at the center and surround positions. The VMAx N, or "Near Field" mode should be selected when your listening position is less than five feet from the speakers. The VMAx F, or "Far Field" mode should be selected when your listening position is greater than five feet from the speakers. The VMAx modes are also available using the Headphones Output 4 . When headphones are being used, the Far Field mode will appear to push the sound field away from your ears, reducing the "inside the head" sensation often experienced when using headphones.	No surround channels
5-Channel Stereo 7-Channel Stereo	This mode takes advantage of multiple speakers to place a stereo signal at both the front and back of a room. Depending on whether the AVR has been configured for either 5.1 or 6.1/7.1 operation, one of these modes, but not both, is available at any time. Ideal for playing music in situations such as a party, it places the same signal this mode at the front-left and surround-left, and front-right and surround-right speakers. The center channel is fed a summed mono mix of the in-phase material of the left and right channels.	No delay available in these modes
SURROUND OFF (STEREO)	This mode turns off all surround processing and presents the pure left- and right-channel presentation of two-channel stereo programs.	No surround channels

Operation

Basic Operation

Once you have completed the initial setup and configuration of the AVR 520, it is simple to operate and enjoy. The following instructions will help you maximize the enjoyment of your new receiver:

Turning the AVR 520 On or Off

- When using the AVR 520 for the first time, you must press the **Main Power Switch 1** on the front panel to turn the unit on. This places the unit in a Standby mode, as indicated by the amber color of the **Power Indicator 3**. Once the unit is in Standby, you may begin a listening session by pressing the **System Power Control 2** on the front panel or the **AVR Selector 6**. Note that the **Power Indicator 3** will turn green. This will turn the unit on and return it to the input source that was last used. The unit may also be turned on from Standby by pressing any of the **Input Selector** buttons on the remote **5 6 7 B C D** or the **Source** button **15** on the front panel.

NOTE: After pressing one of the **Input Selector Buttons 5 7** to turn the unit on, press the **AVR Selector 6** to set the remote control to the AVR 520 functions.

To turn the unit off at the end of a listening session, simply press the **System Power Control 2** on the front panel or the **Power Off Button 1 A** on the remote. Power will be shut off to any equipment plugged into the rear panel **Switched AC Outlet 17** and the **Power Indicator 3** will turn amber.

When the remote is used to turn the unit "off" it is actually placing the system in a Standby mode, as indicated by the amber color of the **Power Indicator 3**.

- To program the AVR 520 for automatic turn-off, press the **Sleep Button 10** on the remote. Each press of the button will decrease the time before shut-down in the following sequence:

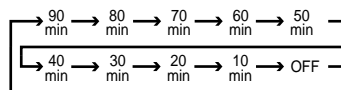

The sleep time will be displayed in the **Preset Number/Sleep Timer Indicator R** and it will count down until the time has elapsed.

When the programmed sleep time has elapsed, the unit will automatically turn off. Note that the front panel display will dim to one half brightness when the Sleep function is

programmed. To cancel the Sleep function, press and hold the **Sleep Button 10** until the information display returns to normal brightness, the Sleep indicator numbers disappear and the words **SLEEP OFF** appear in the **Main Information Display Y**.

When you will be away from home for an extended period of time it is always a good idea to completely turn the unit off with the front panel **Main Power Switch 1**.

NOTE: All preset memories are lost if the unit is left turned off by using the **Main Power Switch 1** for more than two weeks.

Source Selection

- To select a source, press any of the **Source Selector Buttons** on the remote **5 7 C D**.

- The input source may also be changed by pressing the front-panel **Input Source Selector Button 15**. Each press of the button will move the input selection through the list of available inputs.

- As the input is changed, the AVR 520 will automatically switch to the digital input (if selected), surround mode, speaker configuration, output levels, crossover frequency and night mode status that were entered during the configuration process for that source.

- The front panel **Video 4 Inputs 21** may be used to connect a device such as a video game or camcorder to your home entertainment system on a temporary basis.

- As the input source is changed, the new input name will appear momentarily as an on-screen display in the lower third of the video display. The input name will also appear in the **Main Information Display Y** and a green LED will light next to the selected input's name in the front-panel **Input Indicators 23**.

- When an audio source is selected, the last video input used remains routed to the **Video Outputs 26 23** and **Video Monitor Output 1**. This permits simultaneous viewing and listening to different sources.

- When a Video source is selected, the video signal for that input will be routed to the **Video Monitor Output Jack 1** and will be viewable on a TV monitor connected to the AVR 520.

Volume Control

- Adjust the volume to a comfortable level using the front panel **Volume Control 27** or remote **Volume Up/Down 40** buttons.

- When listening in the Stereo mode, with the surround circuits off, the **Balance Control 23** may be used to adjust the relative sound output between the left front and right front speakers.

- To temporarily silence all speaker outputs, press the **Mute Button 43 K**. This will interrupt the output to all speakers and the headphone jack, but it will not affect any recording or dubbing that may be in progress. When the system is muted, the **MUTE Indicator Z** will light in the **Main Information Display 29**. Press the **Mute Buttons 43 K** again to return to normal operation.

- During a listening session, you may wish to adjust the **Bass Control 22** and **Treble Control 24** to suit your listening tastes or room acoustics.

- To set the output of the AVR 520 so that the output is "flat," with the tone controls deactivated, press the **Tone Mode Button 8** once or twice so that the words **Tone Out** appear momentarily in the **Main Information Display Y**. To return the tone controls to an active condition, press the **Tone Mode 8** button once or twice so that the words **Tone In** momentarily appear in the **Main Information Display Y**.

- For private listening, plug the 1/4" stereo phone plug from a pair of stereo headphones into the front panel **Headphone Jack 4**. Note that when the headphone's plug is connected, the word **HEADPHONE** will scroll once across the **Main Information Display Y** and all speakers will be silenced. When the headphone plug is removed, the audio feed to the speakers will be restored.

Surround Mode Selection

One of the most important features of the AVR 520 is its ability to reproduce a full multichannel surround-sound field from digital sources, analog matrix surround-encoded programs and standard stereo programs.

Selection of a surround mode is based on personal taste, as well as the type of program source material being used. For example, motion pictures or TV programs bearing the logo of one of the major surround-encoding processes, such

Operation

as Dolby Surround, DTS Stereo or UltraStereo® may be played in either the Dolby Digital, Dolby Pro Logic II Cinema, DTS Neo:6 Cinema, or Logic 7 Cinema surround modes depending on the source material.

NOTE: Once a program has been encoded with matrix surround information, it retains the surround information as long as the program is broadcast in stereo. Thus, movies with surround sound may be decoded via any of the analog surround modes such as Pro Logic II Cinema, Logic 7 Cinema or DTS Neo:6 Cinema, when they are broadcast via conventional TV stations, cable, pay-TV and satellite transmission. In addition, a growing number of made-for-television programs, sports broadcasts, radio dramas and music CDs are also recorded in surround sound. You may view a list of these programs at the Dolby Laboratories Web site at www.dolby.com.

Even when a program is not listed as carrying intentional surround information, you may find that the Pro Logic II, Logic 7 Enhanced (available only in the 5.1 configuration) or DTS Neo:6, VMaX and the Hall or Theater modes often deliver enveloping surround presentations through the use of the natural information present in all stereo recordings. However, for stereo, but not surround programs, we suggest that you experiment with the other modes.

Surround modes are selected using either the front panel controls or the remote. To select a surround mode from the front panel, press the **Surround Mode Selector 9** to scroll up or down through the list of available modes. To select a surround mode using the remote, first determine which of the surround mode categories you wish to choose from and press the button corresponding to that category: **Dolby Modes 23**, **DTS Surround 24** from digital sources, **DTS Neo:6 30** from analog sources, **Logic 7 25**, **DSP 11** modes or **Stereo 29**.

As you press any of the **Mode Select Buttons 23 24 25 29 30** (except the **Surround Mode Selector 11** as noted below) the surround mode name will scroll across the **Main Information Display Y**. Let the mode scroll so that you read the mode's name, but if you wish to select another mode in that category, press the button again before the mode name scrolls off to the left of the **Main Information Display Y** or on-screen display.

To select from the DSP modes (Hall 1, Hall 2, Theater, VMaX Near or VMaX Far), first press the **Surround Mode Selector 11**. Next,

press the **▲/▼ Buttons 14** to scroll through the list of available modes.

An individual mode indicator will also light up **DEGIJKLMN**. As the surround modes change, a green LED will light next to the current mode in the **Surround Mode Indicators 31** list on the front panel.

Note that the Dolby Digital and DTS 5.1, DTS-ES Matrix and DTS-ES Discrete modes may only be selected when a digital input is in use. In addition, when a digital source is present, the AVR 520 will automatically select and switch to the correct mode, regardless of the mode that has been previously selected. For more information on selecting digital sources, see the following section of this manual.

To listen to a program in traditional two-channel stereo, using the front left and front right speakers only (plus the subwoofer, if installed and configured), press the **Stereo Button 29** until **SURR OFF** appears in the **Main Information Display Y**.

Digital Audio Playback

Digital audio is a major advancement over older analog surround processing systems such as Dolby Pro Logic. It delivers five discrete channels: left front, center, right front, left surround and right surround. Each channel reproduces full frequency range (20Hz to 20kHz) and offers dramatically improved dynamic range and significant improvements to signal-to-noise ratios. In addition, digital systems have the capability to deliver an additional channel that is specifically devoted to low-frequency information. This is the ".1" channel referred to when you see these systems described as "5.1," "6.1" or "7.1". The bass channel is separate from the other channels, but since it is intentionally bandwidth-limited, sound designers have given it that unique designation.

Dolby Digital

Dolby Digital is a standard part of DVD, and is available on specially encoded LD discs and satellite broadcasts and it is a part of the new high-definition television (HDTV) system.

Note that an optional, external RF demodulator is required to use the AVR 520 to listen to the Dolby Digital sound tracks available on laser discs. Connect the RF output of the LD player to the demodulator and then connect the digital output of the demodulator to the **Optical or Coaxial Inputs 31 32 18/20** of the AVR 520. No demodulator is required for use with DVD players or DTS-encoded laser discs.

DTS

DTS is another digital audio system that is capable of delivering 5.1 or 6.1 discrete or matrix soundfield reproduction. Although both DTS and Dolby Digital are digital, they use different methods of encoding the signals, and thus they require different decoding circuits to convert the digital signals back to analog.

DTS-encoded sound tracks are available on select DVD and LD discs, as well as on special audio-only DTS discs. You may use any LD or CD player equipped with a digital output to play DTS-encoded discs with the AVR 520. All that is required is to connect the player's output to either the **Optical or Coaxial Input** on the rear panel **31 32** or front panel **18/20**.

In order to listen to DVDs encoded with DTS sound tracks, the DVD player must be compatible with the DTS signal as indicated by a DTS logo on the player's front panel. Note that early DVD players may not be able to play DTS-encoded DVDs. This does not indicate a problem with the AVR 520, as some players cannot pass the DTS signal through to the digital outputs. If you are in doubt as to the capability of your DVD player to handle DTS discs, consult the player's owner's manual.

Selecting a Digital Source

To utilize either digital mode, you must have properly connected a digital source to the AVR 520. Connect the digital outputs from DVD players, HDTV receivers, satellite systems or CD players to the **Optical or Coaxial Inputs 31 32 18/20**. In order to provide a backup signal and a source for analog stereo recording, the analog outputs provided on digital source equipment should also be connected to their appropriate inputs on the AVR 520 rear panel (e.g., connect the analog stereo audio output from a DVD to the **DVD Audio Inputs 6** on the rear panel when you connect the source's digital outputs).

If you have not already configured an input for a digital source using the on-screen menus as shown on page 21, first select the input using the remote or front panel controls as outlined in this manual. Next, select the digital source by pressing the **Digital Select Button 17/25** and then using the **▲/▼ Buttons 14** on the remote or the **Selector Buttons 7/14** on the front panel to choose any of the **OPTICAL** or **COAXIAL** inputs, as they appear in the **Main Information Display Y** display indicator **BF** or on-screen display. When the digital source is playing, the

Operation

AVR 520 will automatically detect whether it is a multichannel Dolby Digital, DTS source, MP3 or a conventional PCM signal, which is the standard output from CD players. A **Bitstream Indicator A** will light in the **Main Information Display 25** to confirm that the digital signal is Dolby Digital, DTS or PCM.

Digital Status Indicators

When a digital source is playing, the AVR 520 senses the type of bitstream data that is present. Using this information, the correct surround mode will automatically be selected. For example, DTS bitstreams will cause the unit to switch to DTS decoding, and Dolby Digital bitstreams will enable Dolby Digital decoding. When the unit senses PCM data from CDs and LDs, it will allow the appropriate surround sources to be selected manually. Since the range of available surround modes is dependent on the type of digital data that is present, the AVR 520 uses a variety of indicators to let you know what type of signal is present. This will help you to understand the choice of modes.

When a digital source is playing, a **Bitstream Indicator A** will light to show which type of signal is playing:

DOLBY D: When the DOLBY D indicator lights, a Dolby Digital bitstream is being received. Depending on the settings on the source player and specific surround information and number of channels on the disc, a number of surround modes are possible. For discs with full 5.1 audio, only the Dolby Digital and VMAX modes are available.

DTS: When the DTS indicator lights, a DTS bitstream is being received. When the unit senses this type of data, only the applicable DTS mode may be used.

PCM: When the PCM indicator lights, a standard Pulse Code Modulation, or PCM, signal is being received. This is the type of digital audio used by conventional compact disc and laser disc recordings. When a PCM bitstream is present, all modes except Dolby Digital and DTS are available.

HDCCD®: When this indicator lights in conjunction with the PCM indicator, the CD that is playing is encoded through the special High Definition Compatible Digital® process. HDCCD®

HDCCD®, HDCCD®, High Definition Compatible Digital® and Pacific Microsonics™ are either registered trademarks or trademarks of Pacific Microsonics, Inc., in the United States and/or other countries. HDCCD system manufactured under license from Pacific Microsonics, Inc.

discs use 20-bit encoding and other proprietary processing to provide the ultimate in CD listening. Note that HDCD processing is only available in the Stereo (Surround Off) mode.

MP3: When the MP3 indicator lights, a compatible MPEG 1/Layer 3 digital signal is being received. This is the popular audio format used by many computer programs for recording compressed audio files. When an MP3 bitstream is present, the sound will automatically be played in the Stereo (Surround Off) mode. The surround modes are not available during MP3 playback.

In addition to the bitstream indicators, the AVR 520 features a set of unique channel-input indicators that tell you how many channels of digital information are being received and/or whether the digital signal is interrupted. (See Figure 8.)

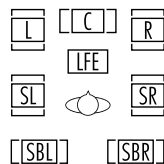

Figure 8

These indicators are the L/C/R/LFE/SL/SR/SBL/SBR letters that are inside the center boxes of the **Speaker/Channel Input Indicators Q** in the front panel **Main Information Display 29**. When a standard analog signal is in use, only the "L" and "R" indicators will light, as analog signals have only left and right channels.

Digital signals, however, may have two, five, six or seven separate channels, depending on the program material, the method of transmission and the way in which it was encoded. When a digital signal is playing, the letters in these indicators will light in response to the specific signal being received. It is important to note that although Dolby Digital, for example, is referred to as a "5.1" system, not all Dolby Digital DVDs or programs are encoded for 5.1. Thus, it is sometimes normal for a DVD with a Dolby Digital soundtrack to trigger only the "L" and "R" indicators.

NOTE: Many DVD discs are recorded with both "5.1" and "2.0" versions of the same soundtrack. When playing a DVD, always be certain to check the type of material on the disc. Most discs show this information in the form of a

listing or icon on the back of the disc jacket. When a disc does offer multiple soundtrack choices, you may have to make some adjustments to your DVD player (usually with the "Audio Select" button or in a menu screen on the disc) to send a full 5.1 feed to the AVR 520. It is also possible for the type of signal feed to change during the course of a DVD playback. In some cases, the previews of special material will only be recorded in 2.0 audio, while the main feature is available in 5.1 audio. The AVR 520 will automatically sense changes to the bitstream and channel count and reflect them in these indicators.

The letters used by the **Speaker/Channel Input Indicators Q** also flash to indicate when a bitstream has been interrupted. This will happen when a digital input source is selected before the playback starts, or when a digital source such as a DVD is paused. The flashing indicators remind you that the playback has stopped due to the absence of a digital signal and not through any fault of the AVR 520. This is normal, and the digital playback will resume once the playback is started again.

Night Mode

A special feature of Dolby Digital is the Night mode, which enables specially encoded Dolby Digital input sources to be played back with full digital intelligibility while reducing the minimum peak level by $\frac{1}{4}$ to $\frac{1}{3}$. This prevents abruptly loud transitions from disturbing others, without reducing the impact of the digital source. The Night mode is available only when Dolby Digital signals with special data are being played.

The Night mode may be engaged when a Dolby Digital DVD is playing by pressing the **Night Mode Button 12** on the remote. Next, press the **▲/▼ Buttons 14** to select either the middle range or full compression versions of the Night mode. To turn the Night mode off, press the **▲/▼ Buttons 14** until the message in the lower third of the video display and the **Main Information Display Y** reads **D-Range Off**.

The Night mode may also be selected to always be on at either level of compression using the options in the **Surround Select** menu. See page 22 for information on using the menus to set this option.

Operation

IMPORTANT NOTES ON DIGITAL PLAYBACK:

- When the digital playback source is stopped, or in a pause, fast forward or chapter search mode, the digital audio data will momentarily stop, and the channel position letters inside the **Speaker/Channel Input Indicators** **Q** will flash. This is normal and does not indicate a problem with either the AVR 520 or the source machine. The AVR 520 will return to digital playback as soon as the data is available and when the machine is in a standard play mode.

- Although the AVR 520 will decode virtually all DVD movies, CDs and HDTV sources, it is possible that some future digital sources may not be compatible with the AVR 520.

- Note that not all digitally encoded programs contain full 5.1-channel audio. Consult the program guide that accompanies the DVD or laser disc to determine which type of audio has been recorded on the disc. The AVR 520 will automatically sense the type of digital surround encoding used and adjust to accommodate it.

- When a digital source is playing, you may not be able to select some of the analog surround modes such as Dolby Pro Logic II, Dolby 3, Stereo, Hall, Theater or Logic 7.

- When a Dolby Digital or DTS source is playing, it is not possible to make an analog recording using the **Tape** **2** and **Video 1** or **Video 2 Record Outputs** **5** **26** **28** **36**. However, the digital signals will be passed through to the **Digital Audio Outputs** **35**.

PCM Audio Playback

PCM (Pulse Code Modulation) is the non-compressed digital audio system used for compact discs and laser discs. The digital circuits in the AVR 520 are capable of high-quality digital-to-analog decoding, and they may be connected directly to the digital audio output of your CD or LD player.

Connections may be made to either the rear panel **Optical** or **Coaxial Inputs** **33** **34** or the front panel **Digital Inputs** **13** **15**.

To listen to a PCM digital source, first select the input for the desired source (e.g., CD). Next press the **Digital Select Button** **24** **17** and then use the **▲/▼ Buttons** **14** on the remote, or the **Selector Buttons** **5** on the front panel, until the desired choice appears in the **Main Information Display** **Y**.

When a PCM source is playing, the **PCM** indicator **A** will light. During PCM playback, you may select any Surround mode except Dolby Digital or DTS. When an HDCD-encoded disc is being played and the DVD or CD player is connected to the AVR 520 via a digital connection, select Surround Off as the Surround mode to enjoy the benefits of the HDCD process.

MP3 Audio Playback

The AVR 520 is one of the first A/V receivers to provide on-board decoding for the MP3 audio format used by computers and portable audio devices. Also, some new CD players are capable of playing back optical discs that are recorded with MP3, rather than standard CD audio information. By offering MP3 decoding, the AVR 520 is able to deliver precise conversion of the digital signals to an analog output, along with the benefits of listening to the MP3 audio through the AVR 520's high-current amplifier and the speakers from your surround system, rather than the smaller speakers and low-powered amplifiers typically used with computers.

To take advantage of the AVR 520's MP3 capabilities, simply connect the PCM output of a computer's sound card or the PCM output of a portable digital audio device to either the rear panel **Digital Inputs** **31** **32** or the front panel **Digital Inputs** **18** **20**. When the digital signal is available, the **MP3 Bitstream Indicator** **A** will light, and the audio will begin playing.

NOTES:

- The AVR 520 is only capable of playing signals in the MP3 (MPEG 1/Layer 3) format. It is not compatible with other computer audio codecs.

- The digital audio input signal may be either optical or coaxial, but the signal must be in the PCM format. Direct connection of USB or serial data outputs is not possible, even though the signals are in the MP3 format. If you have any questions about the data output format from your computer or a sound card, check with the device's owner's manual or contact the manufacturer's technical support area.

- If your computer or sound card's digital output is not capable of direct connection to the AVR, you may use an optional, external transcoder, such as those available from Harman Kardon to convert the USB output of a computer to a format compatible with the AVR. Contact your Harman Kardon dealer for additional details.

Tuner Operation

The AVR 520's tuner is capable of tuning AM, FM and FM Stereo broadcast stations. Stations may be tuned manually, or they may be stored as favorite station presets and recalled from a 30-position memory.

Station Selection

- Press the **AM/FM Tuner Select Button** **7** **C** on the remote to select the tuner as an input. The tuner may be selected from the front panel by either pressing the **Input Source Selector** **15** until the tuner is active or by pressing the **Tuner Band Selector** **11** at any time.

- Press the **AM/FM Tuner Select Button** **7** **C** or **Tuner Band Selector** **11** again to switch between AM and FM so that the desired frequency band is selected.

- Press the **FM Mode** **16** or **Tun-M Button** **19** to select manual or automatic tuning.

When the **AUTO Indicator** **X** is illuminated in the **Main Information Display** **Y** the tuner will only stop at those stations that have a strong enough signal to be received with acceptable quality.

When the **AUTO Indicator** **X** is not illuminated, the tuner is in a manual mode and will stop at each frequency increment in the selected band.

- To select stations, press the **Tuning Selector Button** **10** **21** **E**. When the **AUTO Indicator** **X** is illuminated, press the button for two seconds and then release to cause the tuner to search for the next highest or lowest frequency station that has an acceptable signal. When tuning FM stations in the Auto mode, the tuner will only select stereo stations. To tune to the next station, press the button again. If the **STEREO** **Indicator** **V** is not illuminated, tap the **Tuning Selector Button** **10** **21** **E** to advance one frequency increment at a time, or press and hold it to locate a specific station. When the **TUNED** **Indicator** **W** lights, the station is properly tuned and should be heard with clarity.

- Stations may also be tuned directly by pressing the **Direct Button** **20**, and then pressing the **Numeric Keys** **18** that correspond to the station's frequency. The desired station will automatically be tuned. If you press an incor-

Operation

rect button while entering a direct frequency, press the **Clear Button** **34** to start over.

NOTE: When the FM reception of a station is weak, audio quality will be increased by switching to Mono mode by pressing the **FM Mode Button** **16/19** until the **STEREO** indicator **V** goes out.

Preset Tuning

Using the remote, up to 30 stations may be stored in the AVR 520's memory for easy recall using the front panel controls or the remote.

To enter a station into the memory, first tune the station using the steps outlined above. Then:

1. Press the **Memory Button** **35** on the remote. Note that the **MEMORY Indicator** **U** will be illuminated and flash in the **Main Information Display** **29**.
2. Within five seconds, press the **Numeric Keys** **18** corresponding to the location where you wish to store this station's frequency. Once entered, the preset number will appear in the **Preset Number/Sleep Timer** display **R**.
3. Repeat the process after tuning any additional stations to be preset.

Recalling Preset Stations

- To manually select a station previously entered in the preset memory, press the **Numeric Keys** **18** that correspond to the desired station's memory location.
- To manually tune through the list of stored preset stations one by one, press the **Preset Stations Selector Buttons** **13/33/37** on the front panel or remote.

Tape Recording

In normal operation, the audio or video source selected for listening through the AVR 520 is sent to the record outputs. This means that any program you are watching or listening to may be recorded simply by placing machines connected to the outputs for **Tape Outputs** **4** or **Video 1 or 2 Outputs** **26/28/33/37** in the record mode.

When a digital audio recorder is connected to the **Digital Audio Outputs** **35**, you are able to record the digital signal using a CD-R, MiniDisc or other digital recording system.

Front Panel Connections

In addition to the rear panel digital outputs, the AVR 520 offers Harman Kardon's exclusive configurable front panel output jack feature. For easy connection of portable devices, you may switch the front panel **Digital Coax Jack** **20** or the **Video 4 Jacks** **21** from an input to an output by following these steps:

1. Press the **OSD Button** **22** to view the **MASTER MENU** (Figure 1).
2. Press the **Set Button** **16** to enter the **IN/OUT SETUP** menu (Figure 2).
3. Press the **▼ Button** **14** so that the on-screen **►** cursor is next to **VIDEO 4** or **COAXIAL 3** depending on which input you wish to change to an output. Either input, or both may be changed at any time.
4. Press the **Set Button** **16** and then press either of the **◀/▶ Buttons** **15/37** so that the word **IN** is highlighted.
5. Press the **Set Button** **16** to enter the change.
6. Press the **OSD Button** **22** to exit the menus and return to normal operation.

Note that once the setting is made, the appropriate **Input/Output Status Indicator** **19** will turn red, indicating that the selected analog or digital jacks are now an output, instead of in the default setting as an input. Once changed to an output, the setting will remain as long as the AVR 520 is turned on, unless the setting is changed in the OSD menu system, as described above. Note, however, that once the AVR 520 is turned off, the setting is cancelled. When the unit is turned on again, the front panel jacks will return to their normal default setting as an input. If you wish to use their jacks as an output at a future time, the setting must be changed again using the OSD menu system, as described above.

NOTES:

- The digital outputs are active only when a digital signal is present, and they do not convert an analog input to a digital signal, or change the format of the digital signal. In addition, the digital recorder must be compatible with the output signal. For example, the PCM digital input from a CD player may be recorded on a CD-R or MiniDisc, but Dolby Digital or DTS signals may not.

- Please make certain that you are aware of any copyright restrictions on any material you copy. Unauthorized duplication of copyrighted materials is prohibited by federal law.

Output Level Trim Adjustment

Normal output level adjustment for the AVR 520 is established using the test tone, as outlined on pages 23 and 24. In some cases, however, it may be desirable to adjust the output levels using program material such as a test disc, or a selection you are familiar with. Additionally, the output level for the subwoofer can only be adjusted using this procedure.

To adjust the output levels using program material, first set the reference volume for the front left and front right channels using the **Volume Control** **27/40/1**.

If you are using a disc with test signals or an external signal generator as the source from which to trim the output levels, you may use the EzSet feature of the remote to guide you to the correct SPL level. To use the remote for this purpose, press and quickly release the **SPL Indicator Select** **41** to activate the sensor. While the test tone is circulating, the **Program/SPL Indicator** **3** will change color to indicate the level. Adjust the level as shown above until the LED lights green for all channels. When it is red the level is too high; when it is amber the level is too low. Press the **SPL Indicator Select** **41** to turn the sensor and indicator off.

Once the reference level has been set, press the **Channel Select** button **13/26** and note that **FRONT LEVEL** will appear in the **Main Information Display** **Y**. To change the level, first press the **Set Button** **16/12**, and then use the **Selector Buttons** **7/14** or the **▲/▼ Buttons** **14** to raise or lower the level. DO NOT use the volume control, as this will alter the reference setting.

Once the change has been made, press the **Set Button** **16/12** and then press the **Selector Buttons** **7/14** or the **▲/▼** buttons **14** to select the next output channel location that you wish to adjust. To adjust the subwoofer level, press the **Selector Buttons** **7/14** or the **▲/▼ Buttons** **14** until **WOOFER LEVEL** appears in the **Main Information Display** **Y** or on-screen display.

Press the **Set Button** **16/12** when the name of the desired channel appears in the **Main**

Operation

Information Display **Y** and on-screen display, and follow the instructions shown earlier to adjust the level.

Repeat the procedure as needed until all channels requiring adjustment have been set. When all adjustments have been made and no further adjustments are made for five seconds, the AVR 520 will return to normal operation.

The channel output for any input may also be adjusted using the full-OSD on-screen menu system. First, set the volume to a comfortable listening level using the **Volume Control** **26 40 1**. Then, press the **OSD Button** **22** to bring up the **MASTER MENU** (Figure 1). Press the **▼ Button** **14** four times until the on-screen ► cursor is next to the **CHANNEL ADJUST** line. Press the **Set Button** **16** to activate the **CHANNEL ADJUST** menu.

Once the menu appears on your video screen, first use the **▲/▼ Buttons** **14** to move the on-screen ► cursor so that it is next to the **TEST TONE** line. Press the **◀▶ Buttons** **15 37** so that **OFF** is highlighted. This will turn off the test tone and allow you to use your external test disc or other source material as the reference. Then, use the **▲/▼ Buttons** **14** to select the channels to be adjusted. At each channel position use the **◀▶ Buttons** **15 37** to change the output level. Remember, the goal is to have the output level at each channel be equal when heard at the listening position.

If you wish to reset all the levels to their original factory default of 0dB offset, press the **▲/▼ Buttons** **14** so that the on-screen cursor is next to the **CHANNEL RESET** line and press the **◀▶ Buttons** **15 37** so that the word **ON** is highlighted. After the levels are reset, resume the procedure outlined above

to reset the levels to the desired settings. When all adjustments are done, press the **▲/▼ Buttons** **14** to move the on-screen ► cursor so that it is next to **RETURN TO MASTER MENU** and then press the **Set Button** **16** if you wish to go back to the main menu to make other adjustments. If you have no other adjustments to make, press the **OSD Button** **22** to exit the menu system.

NOTE: The output levels may be separately trimmed for each digital and analog surround mode. If you wish to have different trim levels for a specific mode, select that mode and then follow the instructions in the steps shown earlier.

6-Channel/8-Channel Direct Input

The AVR 520 is equipped for future expansion through the use of optional, external adapters for formats that the AVR 520 may not be capable of processing or to allow connection to the output of high-resolution optical audio playback systems such as DVD-Audio or SACD. When a device with six-channel outputs (5.1 audio) is used, connect the source device to the **6-Channel Direct Inputs** **9**. When a device with eight-channel outputs (7.1 audio) is used, connect the additional Surround Back Left (SBL) and Surround Back Right (SBR) outputs to the **8-Channel Direct Inputs** **10** on the AVR. To select these inputs, press the **6-Channel/8-Channel Direct Button** **8** on the remote until the desired input configuration appears in the **Main Information Display** **Y**.

Note that when the 6-Channel or 8-Channel Direct Input is in use, you may not select a surround mode, as the external decoder determines the processing in use. In addition, there is no signal at the record outputs or bass management when the 6-Channel or 8-Channel Direct Input is in use.

Memory Backup

This product is equipped with a memory backup system that preserves the system configuration information and tuner presets if the unit is accidentally unplugged or subjected to a power outage. This memory will last for approximately two weeks, after which time all information must be reentered.

Advanced Features

The AVR 520 is equipped with a number of advanced features that add extra flexibility to the unit's operation. While it is not necessary to use these features to operate the unit, they provide additional options that you may wish to use.

Display Brightness

The AVR 520's **Main Information Display** 29 is set at a default brightness level that is sufficient for viewing in a normally lit room. However, in some home-theater installations, you may wish to occasionally lower the brightness of the display, or turn it off completely.

To change the display brightness setting for a specific listening session, you will need to make an adjustment in the **ADVANCED** menu. To start the adjustment, press the **OSD Button** 22 to bring the **MASTER MENU** to the screen. Press the **▼ Button** 14 six times, until the on-screen ► cursor is next to the **ADVANCED** line. Press the **Set Button** 16 to enter the **ADVANCED** menu (Figure 9).

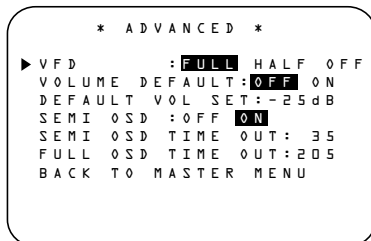

Figure 9

To change the brightness setting, at the **ADVANCED** menu, make certain that the on-screen ► cursor is next to the **VFD** line, and press the ► **Button** 37 until the desired brightness level is highlighted in the video display. When **FULL** is highlighted, the display is at its normal brightness. When **HALF** is highlighted, the display is at half the normal brightness level. When **OFF** is highlighted, all of the indicators in the **Main Information Display** 29 will go dark. Note, however, that the green LEDs for the **Input Indicators** 28 and the **Surround Mode Indicators** 31, as well as for the **Power Indicator** 3, will always remain lit to remind you that the unit is turned on.

The display brightness may also be changed by pressing and holding the **Set Button** 12 on the front for three seconds until the message in the **Main Information Display** 29 reads **VFD FULL**. Within five seconds, press the front panel **Selector Buttons** 5 until the

desired brightness display level is shown. At that point, press the **Set Button** 21 again to enter the setting.

Once the desired brightness level is selected, it will remain in effect until it is changed again or until the unit is turned off.

If you wish to make other adjustments, press the ▲/▼ **Buttons** 14 until the on-screen ► cursor is next to the desired setting or the **RETURN TO MASTER MENU** line and press the **Set Button** 16. If you have no other adjustments to make, press the **OSD Button** 22 to exit the menu system.

Turn-On Volume Level

As is the case with most audio/video receivers, when the AVR 520 is turned on, it will always return to the volume setting in effect when the unit was turned off. However, you may prefer to always have the AVR 520 turn on at a specific setting, regardless of what was last in use when the unit was turned off. To change the default condition so that the same volume level is always used at turn-on, you will need to make an adjustment in the **ADVANCED** menu. To start the adjustment, press the **OSD Button** 22 to bring the **MASTER MENU** (Figure 1) to the screen. Press the ▼ **Button** 14 six times, until the on-screen ► cursor is next to the **ADVANCED** line. Press the **Set Button** 16 to enter the **ADVANCED** menu (Figure 9).

At the **ADVANCED** menu make certain that the on-screen ► cursor is next to the **VOLUME DEFAULT** line by pressing the ▲/▼ **Buttons** 14 as needed. Next, press the ► **Button** 37 so that the word **ON** is highlighted in the video display. Next, press the ▼ **Button** 14 once so that the on-screen ► cursor is next to the **DEFAULT VOL SET** line. To set the desired turn-on volume, press the ◀/▶ **Buttons** 15 37 until the desired volume level is shown on the **DEFAULT VOL SET** line. Note that this setting may NOT be made with the regular volume controls.

NOTE: Since the setting for the turn-on volume cannot be heard while the setting is being made, you may wish to determine the setting before making the adjustment. To do this, listen to any source and adjust the volume to the desired level using the regular volume controls 20 43 1. When the desired volume level to be used at turn-on is reached, make a note of the setting as it appears in the lower third of the video screen or in the **Main Information**

Display 29. (A typical volume level will appear as a negative number such as -25dB.) When making the adjustment, use the ◀/▶ **Buttons** 15 33 to enter this setting.

Unlike some of the other adjustments in this menu, the turn-on volume default will remain in effect until it is changed or turned off in this menu, even when the unit is turned off.

If you wish to make other adjustments, press the ▲/▼ **Buttons** 14 until the on-screen ► cursor is next to the desired setting or the **RETURN TO MASTER MENU** line and press the **Set Button** 16. If you have no other adjustments to make, press the **OSD Button** 22 to exit the menu system.

Semi-OSD Settings

The semi-OSD system places one-line messages at the lower third of the video display screen whenever the Volume, Input Source, Surround mode or tuner frequency of any of the configuration settings are changed. The semi-OSD system is helpful in that it enables you to have feedback on any control changes or remote commands using the video display when it is difficult to view the front panel displays. However, you may occasionally prefer to turn these displays off for a particular listening session. You may also want to adjust the length of time the displays remain on the screen. Both of those options are possible with the AVR 520.

To turn off the semi-OSD system, you will need to make an adjustment in the **ADVANCED** menu (Figure 9). To start the adjustment, press the **OSD Button** 22 to bring the **MASTER MENU** to the screen. Press the ▼ **Button** 14 six times, until the on-screen ▼ cursor is next to the **ADVANCED** line. Press the **Set Button** 16 to enter the **ADVANCED** menu.

At the **ADVANCED** menu, make certain that the on-screen ► cursor is next to the **SEMI OSD DEFAULT** line by pressing the ▲/▼ **Buttons** 14 as needed. Next, press the ► **Button** 37 so that the word **OFF** is highlighted in the video display.

Note that this setting is temporary and will remain active only until it is changed or until the AVR 520 is turned off. Once the unit is turned off, the semi-OSD displays will remain activated, even if they were switched off for the previous listening session.

Advanced Features

To change the length of time that the semi-OSD displays remain on the screen, go to the **ADVANCED** menu as outlined earlier, and press the **▲/▼ Buttons 14** as needed, until the on-screen **▶** cursor is next to the **SEMI OSD TIME OUT** line. Next, press the **◀/▶ Buttons 15/37** until the desired time in seconds is displayed. Note that unlike most of the other options in this menu, this is a permanent setting change, and the time-out entry will remain in effect until it is changed, even when the unit is turned off.

If you wish to make other adjustments, press the **▲/▼ Buttons 14** until the on-screen **▶** cursor is next to the desired setting or the **RETURN TO MASTER MENU** line and press the **Set Button 16**. If you have no other adjustments to make, press the **OSD Button 22** to exit the menu system.

Full-OSD Time-Out Adjustment

The **FULL OSD** menu system is used to simplify the setup and adjustment of the AVR 520, using a series of on-screen menus. The factory default setting for these menus leaves them on the screen for 20 seconds after a period of inactivity before they disappear from the screen (Time-Out). Time-Out is a safety measure to prevent image retention of the menu text in your monitor or projector, which might happen if it were left on indefinitely. However, some viewers may prefer a slightly longer or shorter period before the Time Out display.

To change the Full-OSD Time-Out, you will need to make an adjustment in the **ADVANCED** menu (Figure 9). To start the adjustment, press the **OSD Button 22** to bring the **MASTER** menu to the screen. Press the **▼ Button 14** six times, until the on-screen **▼** cursor is next to the **ADVANCED** line. Press the **Set Button 16** to enter the **ADVANCED** menu (Figure 9).

At the **ADVANCED** menu (Figure 9) make certain that the on-screen **▶** cursor is next to the **FULL OSD TIME OUT** line by pressing the **▲/▼ Buttons 14** as needed. Next, press the **◀/▶ Buttons 15/37** until the desired time is displayed in seconds. Note that unlike most of the other options in this menu, this is a permanent setting change, and the Time-Out entry will remain in effect until it is changed, even if the unit is turned off.

If you wish to make other adjustments, press the **▲/▼ Buttons 14** until the on-screen **▶** cursor is next to the desired setting or the **RETURN TO MASTER MENU** line and press the **Set Button 16**. If you have no other adjustments to make, press the **OSD Button 22** to exit the menu system.

Multiroom Operation

The AVR 520 is fully equipped to operate as the control center for a multiroom system with optional remote external infrared (IR) sensors, speakers and power amplifiers. Although some multiroom installations will require the services of a specially trained installer, it is possible for the average do-it-yourself hobbyist to install a simple remote room system.

Installation

The key to remote room operation is to link the remote room to the AVR 520's location with wire for an infrared link and speakers or an amplifier. For installation instructions for Multiroom use, see page 16.

Multiroom Setup

Once the audio and IR link connections have been made, the AVR 520 needs to be configured for multiroom operation using the steps below. Press the **OSD Button** **22** to bring the **MASTER** menu (Figure 1) to the screen. Press the **▼ Button** **14** five times, until the on-screen ► cursor is next to the **MULTI - ROOM** line. Press the **Set Button** **16** to enter the **MULTI - ROOM** menu (Figure 10).

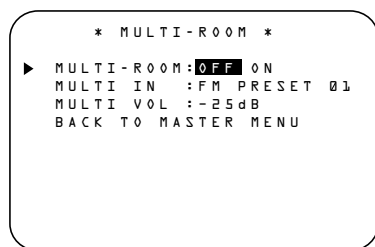

Figure 10

When the **MULTI - ROOM** menu appears, the on-screen ► cursor will be at the **MULTI - ROOM** line. Since this line is used to turn the system on and off, do not make an adjustment here unless you wish to turn the system on at this time. To turn the system on, press the **► Button** **37** so that **ON** is highlighted. If you do not wish to turn the system on at this time or to proceed to the next step, press the **▼ Button** **14** once so that the ► on-screen cursor is next to the **MULTI IN** line.

At the **MULTI IN** line, press the **◀/► Buttons** **15** **31** until the desired input to the multiroom system appears in the highlighted video. When the selection has been made, press the **▼ Button** **14** once so that the ► on-screen cursor is next to the **MULTI VOL** line.

At the **MULTI VOL** line, press the **◀/► Buttons** **15** **37** until the desired volume level for the multiroom system is entered. DO NOT use the regular volume control knobs for this setting. When all settings for the multiroom setup have been made, press the **▲/▼ Buttons** **14** until the on-screen ► cursor is next to the **RETURN TO MASTER MENU** line. If you have no other adjustments to make, press the **OSD Button** **22** to exit the menu system.

Multiroom Operation

When operating the AVR 520 from a remote room location where an IR sensor link has been connected to the AVR 520's rear panel **Multiroom IR Input** **25**, you may use either the main remote control or the Zone II remote. To turn on the multiroom feed, press any of the **Input Selector** buttons on the Zone II remote **B C D** or the main remote **5 6 7**. Press the **AVR Selector** **6 B** to turn the unit on to the last source, or any of the other **Selector** buttons to turn on to a specific source.

As long as an IR feed to the AVR 520 has been established from the remote room, using any of the buttons on either remote will control the remote location volume **40 1**, change the tuner frequency **21 G**, change the tuner preset **33 G** or mute the output **43 ●**.

If the **Remote IR Output Jack** **23** on the AVR 520 is connected to an IR Input jack on compatible Harman Kardon audio components such as CD, DVD or cassette players, the transport functions of those machines may also be controlled using the **Transport Controls** **26 28 E F G H J** on either remote control.

To turn the system off from the remote room, press the **Power Off Button** **1 A**. Remember that the AVR 520 may be turned on or off from the remote room, regardless of the system's operation or status in the main room.

NOTE: When the tuner is selected as the source for the remote zone, any change to the frequency or preset will also change the station being listened to in the main room, if the tuner is in use there. Similarly, if someone in the main room changes the station, the change will also impact the remote room.

To activate the feed to the remote room, while you are in the main listening room where the AVR 520 is located, press the **Multiroom**

Button **39** on the remote. Next, press the **Set Button** **16**. Press the **▲/▼ Buttons** **14** to turn the multiroom feed on or off. When the multiroom system is on, the **Multi Indicator** **0** will light in the **Main Information Display** **29**, and the **Main Information Display** **Y** or OSD will display **MULTI ON**. Press the **Set Button** **16** to enter the setting.

When the multiroom system is turned on, the input selected using the multiroom menu will be fed to the **Multiroom Output Jacks** **8** on the rear panel. The volume will be as set in the previous selection, although it may also be adjusted using an optional IR sensor and the Zone II remote in the remote location or on the optional audio power amplifier connected to the **Multiroom Output Jacks** **8**.

Once the multiroom system is turned on, it will remain on even if the AVR 520 is placed in the Standby mode in the main room by pressing the **Power Off Button** **A** or the **System Power Control** **2** on the front panel. To turn off the multiroom system, even when the AVR is in Standby mode in the main listening room, press the **Multiroom Button** **39** and then the **Set Button** **16**. Press the **▲/▼ Buttons** **14** so that the **Multi Indicator** **0** in the **Main Information Display** **29** goes out, and the **Main Information Display** **Y** or OSD will display **MULTI OFF**. Press the **Set Button** **16** to enter the setting and turn the unit off.

Even when the AVR 520 is turned off in the main room, the multiroom system may be turned on at any time by pressing the **Multiroom Button** **39**, or any of the **Selector Buttons** **B C D** in the remote room.

Programming the Remote

The AVR 520 is equipped with a powerful remote control that will control not only the receiver's functions, but also most popular brands of audio and video equipment, including CD players, cassette decks, TV sets, cable boxes, VCRs, satellite receivers and other home-theater equipment. Once the AVR 520's remote is programmed with the codes for the products you own, it is possible to eliminate most other remotes and replace them with the convenience of a single, backlit universal remote control.

Programming the Remote

The AVR 520 remote is factory-programmed for all AVR functions, as well as those of most Harman Kardon CD changers, DVD players, CD players and cassette decks. In addition, by following one of the methods below, you may program the remote to operate a wide range of devices from other manufacturers.

Direct Code Entry

This method is the easiest way to program your remote to work with different products.

1. Use the tables in the following pages to determine the three-digit code or codes that match both the product type (e.g., VCR, TV) and the specific brand name. If there is more than one number for a brand, make note of the different choices.
2. Turn on the unit you wish to program into the AVR 520 remote.
3. Press and hold both the **Input Selector** **5** for the product you wish to control (e.g., VCR, TV) and the **Mute** button **43** at the same time. When the **Program/SPL Indicator** **3** turns amber and begins flashing, release the buttons. It is important that you begin the next step within 20 seconds.
4. Point the AVR 520's remote towards the unit to be programmed, and enter the first three-digit code number using the **Numeric Keys** **18**. If the unit turns off, the correct code has been entered. Press the **Input Selector** **5** again, and note that the red light will flash three times before going dark to confirm the entry.
5. If the device to be programmed in does NOT turn off, continue to enter three-digit code numbers until the equipment turns off. At this point, the correct code has been entered. Press the **Input Selector** **5** again and note that the red light under the

Input Selector will flash three times before going dark to confirm the entry.

6. Try all of the functions on the remote to make certain that the product operates properly. Keep in mind that many manufacturers use a number of different combinations of codes, so it is a good idea to make certain that not only the Power control, but the volume, channel and transport controls work as they should. If functions do not work properly, you may need to use a different remote code.
7. If a code cannot be entered to turn the unit off, if the code for your product does not appear in the tables in this manual, or if not all functions operate properly, try programming the remote with the Auto Search Method.

Auto Search Method

If the unit you wish to include in the AVR 520's remote is not listed in the code tables in this manual or if the code does not seem to operate properly, you may wish to program the correct code using the Auto Search method that follows:

1. Turn on the unit that you wish to include in the AVR 520 remote.
2. Press the **Input Selector** **5** for the type of product to be entered (e.g., VCR, TV) and the **Mute** button **43** at the same time. Hold both buttons until the red light under the **Input Selector** **5** stays lit. Note that the next step must take place while the red light is on, and it must begin within 20 seconds after the light appears.
3. Point the AVR 520 remote towards the unit to be programmed, and press either **▲** or **▼** button **14**. Each press will send out a series of codes from the remote's built-in database. When the unit being programmed turns off, release **▲/▼** button **14**, as that is your indication that the correct code is in use.
4. Press the **Input Selector** **5**, and note that the red light under the Input Selector will flash three times before going dark to confirm the entry.
5. Try all of the functions on the remote to make certain that the product operates. Keep in mind that many manufacturers use a number of different combinations of codes, and it is a good idea to make certain that not only the Power control works, but

also the volume, channel and transport controls, as appropriate. If all functions do not work properly, you may need to Auto-Search for a different code, or enter a code via the Direct Code Entry method.

Code Readout

When the code has been entered using the Auto Search method, it is always a good idea to find out the exact code so that it may be easily reentered if necessary. You may also read the codes to verify which device has been programmed to a specific Control Selector button.

1. Press and hold both the **Input Selector** **5** for the device you wish to find the code for and the **Mute** button **43** at the same time. Note that the **Program/SPL Indicator** **3** will initially turn amber. Release the buttons and begin the next step within 20 seconds.
2. Press the **Set** button **16**. The **Program/SPL Indicator** **3** will then blink green in a sequence that corresponds to the three-digit code, with a one-second pause between each digit. Count the number of blinks between each pause to determine the digit of the code. One blink is the number 1, two blinks is the number 2, and so forth. Ten blinks are used to indicate a "0."

Example: One blink, followed by a one-second pause, followed by six blinks, followed by a one-second pause, followed by ten blinks indicates that the code has been set to 160.

For future reference enter the Setup Codes for the equipment in your system here:

DVD _____ CD _____
VID1/VCR _____ VID2/TV _____
VID3/CBL _____ VID3/SAT _____
VID4 _____ TAPE _____

Learning Codes

In addition to using codes from the remote's internal code library, the AVR 520's remote is able to "learn" codes from remotes that may not be in the code library. In addition, you may use this function to "learn over" the codes from a preprogrammed device to add functions not included in the preprogrammed codes. To learn or transfer codes from an IR remote to the AVR 520's remote, follow these steps:

1. Place the front of the original remote with

Programming the Remote

the code being sent so that it is facing the **IR Transmitter Window 2** on the AVR 520 remote "head-to-head." The remotes should be between one and three inches apart.

2. Select the button on the remote that you wish to use as the device selector for the codes about to be entered. This may be any of the **Input Selectors 5**.
3. Press the **Input Selector 5** button chosen and the **Learn Button 8** at the same time. Hold these buttons until the **Program/SPL Indicator 3** flashes amber and the light under the device selector button turns red. Release the buttons.
4. Press the button on the AVR 520 remote that you wish to program. Note that the **Program/SPL Indicator 3** will stop flashing.
5. Within five seconds, press and hold the button on the original remote that you wish to "teach" into the AVR 520 remote. When the **Program/SPL Indicator 3** turns green three times, release the button. Note that the Program Indicator will then begin to flash amber again.

NOTE: If the **Program/SPL Indicator 3** turns red during Step 5 or 6, the programming was not successful. Repeat the steps to see if the code will "take."

6. Repeat Steps 4 through 6 for each button on the source remote that you wish to transfer to the AVR 520 remote.
7. Once all codes have been transferred from the original source remote to the AVR 520 remote, press the **Learn Button 8**.
8. Repeat Steps 1 through 7 for any additional remotes you wish to "teach" into the AVR 520 Remote.

Erasing Learned Codes

The AVR 520's remote allows you to remove or erase, the code learned into a single button for a single device, to remove or erase the code set for all the codes that have been programmed into specific device buttons, or to erase all commands that have been learned to all devices.

To erase a single learned code from within a single device's settings, follow these steps:

1. Press and hold both the **Input Selector 5 6 7** within which the individual button to be erased has been programmed and the **Learn Button 8**.
2. When the red LED under the **Input Selector** turns red and the **Program/SPL Indicator 3** flashes amber, release the buttons.
3. Press and release the **Input Selector 5 6 7** again for the device within which the individual button to be erased has been programmed.
4. Press the **7 Button 18** four times.
5. Press and release the individual button for which the code is to be erased. The **Program/SPL Indicator 3** will blink green two times and then return to amber.
6. To erase other buttons within the same device, press them as noted in Step 5.
7. When all buttons to be erased have been pressed, press the **Learn Button 8** to complete the process.

To erase all codes within a single device, follow these steps:

1. Press and hold both the **Input Selector 5 6 7** for which you wish to erase the codes and the **Learn Button 8**.
2. When the red LED under the **Input Selector** turns red and the **Program/SPL Indicator 3** flashes amber, release the buttons.
3. Press and release the **Input Selector 5 6 7** again for the device whose codes you wish to erase.
4. Press the 8 button **18** four times.
5. The **Program/SPL Indicator 3** will turn off and the red light under the **Input Selector** will flash on and off once to indicate that the codes have been erased.

To erase all codes that have been programmed to all devices in the remote, follow these steps:

1. Press any **Input Selector 5 6 7** for which you wish to erase the codes and also the **Learn Button 8**.

2. When the red LED under the **Input Selector** turns red and the **Program/SPL Indicator 3** flashes amber, release the buttons.
3. Press and release the **Input Selector 5 6 7** again for the device whose codes you wish to erase.
4. Press the **9 Button 18** four times.
5. The **Program/SPL Indicator 3** will turn off and the red light under the **Input Selector** will flash on and off once to indicate that the codes have been erased.

Macro Programming

Macros enable you to easily repeat frequently used combinations of commands with the press of a single button on the AVR 520's remote control. Once programmed, a macro will send out up to 19 different remote codes in a predetermined sequential order enabling you to automate the process of turning on your system, changing devices, or other common tasks. The AVR 520's remote can store up to five separate macro command sequences: one that is associated with the **Power On Button 1** and four more that are accessed by pressing the **Macro Buttons 31**.

1. Press the **Mute Button 43** and the **Macro Button 31** to be programmed or the **Power On Button 1** at the same time. Note that an **Input Selector** will light red, and the **Program/SPL Indicator 3** will flash amber.
2. Enter the steps for the macro sequence by pressing the button for the actual command step. Although the macro may contain up to 19 steps, each button press, including those used to change devices, counts as a step. The **Program/SPL Indicator 3** will flash green to confirm each button press as you enter commands.

NOTE: While entering commands for Power On/Off of any device during a macro sequence, press the **Mute Button 43**. DO NOT press the actual Power button.

3. When all the steps have been entered, press the **Sleep Button 10** to enter the commands. The red light under the **Input Selectors 5 6** will blink and then turn off.

Programming the Remote

Example: To program the Macro 1 button so that it turns on the AVR 520, TV and a Cable Box, follow these steps:

- Press the **Macro 1 Button** 31 and **Mute Button** 43 at the same time and then release them.
- Note that the **Program/SPL Indicator** 3 will flash amber.
- Press the **AVR Selector** 6.
- Press the **Mute Button** 43 to store the AVR 520's power on command.
- Press the **VID 2 Input Selector Button** 5 to indicate the next command is for "TV Power On."
- Press the **Mute Button** 43 to store the TV Power On Command.
- Press the **VID 3 Input Selector Button** 5 to indicate the next command is for "Cable Power On."
- Press the **Mute Button** 43 to store the Cable Power On command.
- Press the **Sleep/Channel Up Button** 10 to complete the process and store the macro sequence.

After following these steps, each time you press the **Macro 1 Button** 31, the remote will send the Power On/Off command.

Erasing Macro Commands

To remove the commands that have been programmed into one of the Macro buttons, follow these steps:

1. Press the **Mute Button** 43 and the **Macro Button** 31 that contains the commands you wish to erase.
2. Note that the **Program/SPL Indicator** 3 will flash amber, and the LED under the **AVR Selector** 6 will turn red.
3. Within ten seconds, press the **Surround Mode Selector/Channel Down Button** 11.
4. The red LED under the **AVR Selector** will go out, and the **Program/SPL Indicator** 3 will turn green and flash three times before it goes out.
5. When the **Program/SPL Indicator** 3 goes out, the Macro has been erased.

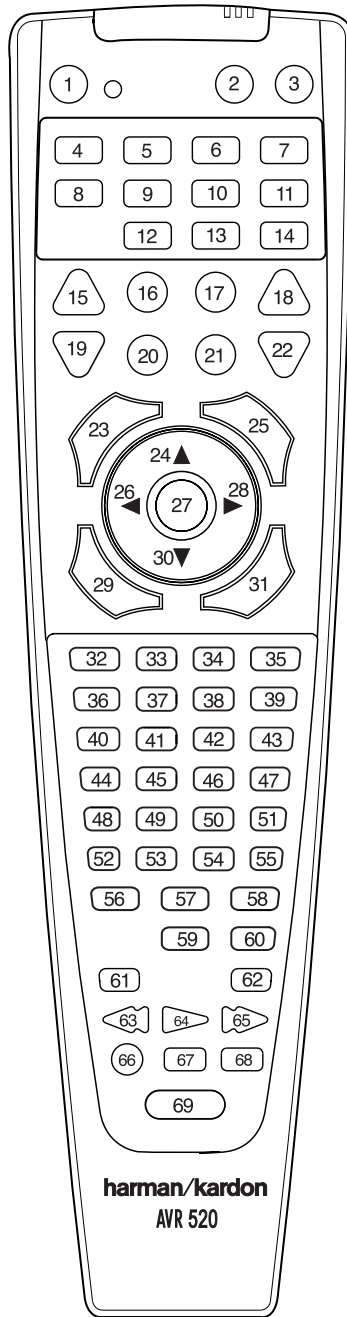

Programmed Device Functions

Once the AVR 520's remote has been programmed for the codes of other devices, press the appropriate **Input Selector** 5 to change the remote from controlling the AVR 520 to controlling the additional product. When you press any one of the selectors, it will briefly flash in red to indicate that you have changed the device being controlled.

When operating a device other than the AVR 520, the controls may not correspond exactly to the function printed on the remote or button. Some commands, such as the volume control, are the same as they are with the AVR 520. Other buttons will change their function so that they correspond to a secondary label on the remote. For example, the Sleep and Surround mode selector buttons also function as the Channel Up and Channel Down buttons when operating most TV sets, VCRs or cable boxes. The Channel Up/Down indication is printed directly on the remote. For many standard CD players, cassette decks, VCRs and DVD functions, the standard function icons are printed on top of the buttons.

For some products, however, the function of a particular button does not follow the command printed on the remote. In order to see which function a button controls, consult the Function List tables printed on page 43. To use those tables, first check the type of device being controlled (e.g., TV, VCR). Next, look at the remote control diagram pictured at the left. Note that each button has a number on it.

To find out what function a particular button has for a specific device, find the button number on the Function List and then look in the column for the device you are controlling. For example, button number 45 is the Direct button for the AVR 520, but it is the "Favorite" button for many cable television boxes and satellite receivers. Button number 31 is the Delay button for the AVR 520, but the Open/Close button for CD players.

NOTE: That the numbers used to describe the button functions at the left for the purposes of describing how a button operates are a different set of numbers than those used in the rest of this manual to describe the button functions for the AVR 520.

Programming the Remote

Notes on Using the AVR 520 Remote With Other Devices.

- Manufacturers may use different code sets for the same product category. For that reason, it is important that you check to see whether the code set you have entered operates as many controls as possible. If it appears that only a few functions operate, check to see whether another code set will work with more buttons.
- When a button is pressed on the AVR 520 remote, the red light under the **Input Selector 5** for the product being operated should flash briefly. If the Device Control Selector flashes for some but not all buttons for a particular product, it does NOT indicate a problem with the remote but rather that no function is programmed for the button being pushed.

Volume Punch-Through

The AVR 520's remote may be programmed to operate the **Volume Control 40** and **Mute 43** functions of either the TV or the AVR 520 in conjunction with any of the devices controlled by the remote. For example, since the AVR 520 will likely be used as the sound system for TV viewing, you may wish to have the AVR 520's volume activated, although the remote is set to run the TV. Either the AVR 520 or TV volume control may be associated with any of the remote's devices. To program the remote for Volume Punch-Through, follow these steps:

- Press the **Input Selector 5** for the unit you wish to have associated with the volume control and the **Mute Button 43** at the same time until the red light appears under the **Input Selector 5** and note that the **Program/SPL Indicator 3** will flash amber.
- Press the **Volume Up Button 40** and note that the **Program/SPL Indicator 3** will stop flashing and stay amber.
- Press either the **AVR Selector 6** or the **Input Selector 5**, depending on which system's volume control you wish to have attached for the punch-through mode. The **Program/SPL Indicator 3** will blink green three times and then go out to confirm the data entry.

Example: To have the AVR 520's volume control activated even though the remote is set to control the TV, first press the **Video/TV Input Selector 5** and the **Mute Button 43** at the same time. Next, press the **Volume Up Button 40**, followed by the **AVR Selector 6**.

NOTE: Should you wish to return the remote to the original configuration after entering a Volume Punch-Through, you will need to repeat the steps shown above. However, press the same Input Selector in Steps 1 and 3.

Channel Control Punch-Through

The AVR 520's remote may be programmed to operate so that the channel control function for either the TV, cable or satellite receiver used in your system may be used in conjunction with one of the other devices controlled by the remote. For example, while using and controlling the VCR, you may wish to change channels on a cable box or satellite receiver without having to change the device selected by the AVR 520 or the remote. To program the remote for Channel Control Punch-Through, follow these steps:

- Press the **Input Selector Button 5** for the device you wish to have the channel control associated with and the **Mute Button 43** at the same time until the red light appears under the **Input Selector 5** and the **Program/SPL Indicator 3** flashes amber.
- Press the **Volume Down Button 40**. The **Program/SPL Indicator 3** will stop flashing and stay amber.
- Press and release the **Input Selector Button 5** for the device that will be used to change the channels. The **Program/SPL Indicator 3** will blink green three times and then go out to confirm the data entry.

Example: To control the channels using your Cable Box or Satellite Receiver while the remote is set to control the VCR, first press the **VID 1/VCR Input Selector Button 5** and the **Mute Button 43** at the same time. Next, release them and press the **Volume Down Button 40**, followed by the **VID 2/TV Input Selector Button 5**.

NOTE: To remove the Channel Control Punch-Through and return the remote to its original configuration, repeat the steps shown in the

example above. However, press the **VID 1/VCR Input Selector** in Steps 1 and 3.

Transport Control Punch-Through

The AVR 520's remote may be programmed to operate so that the **Transport Control Functions 26** (Play, Stop, Fast Forward, Rewind, Pause and Record) for a VCR, DVD or CD will operate in conjunction with one of the other devices controlled by the remote. For example, while using and controlling the TV, you may wish to start or stop your VCR or DVD without having to change the device selected by the AVR 520 or the remote. To program the remote for Transport Control Punch-Through, follow these steps:

- Press the **Input Selector 5** for the device you wish to have the channel control associated with and the **Mute Button 43** at the same time until the red light appears under the **Input Selector 5** and the **Program/SPL Indicator 3** flashes amber.
- Press the **Play Button 26**. The **Program/SPL Indicator 3** will stop flashing and stay amber.
- Press and release the **Input Selector Button 5** for the device that will be used to change the channels. The **Program/SPL Indicator 3** will blink green three times and then go out to confirm the data entry.

Example: To control the transport of a DVD player while the remote is set to control the TV, first press the **VID 2/TV Input Selector Button 5** and the **Mute Button 43** at the same time. Next, release them and press the **Play Button 26**, followed by the **DVD Input Selector Button 5**.

NOTE: To remove the Channel Control Punch-Through and return the remote to its original configuration, repeat the steps shown in the example above. However, press the **VID 2/TV Input Selector** in Steps 1 and 3.

NOTE: Before programming the remote for Volume, Channel or Transport Punch-Through, make certain that any programming needed for the specific TV, CD, DVD, Cable or Satellite Receivers has been completed.

Programming the Remote

Reassigning Device Control Selectors

Although each **Input Selector 5** is normally assigned to the category of product shown on the remote, it is possible to reassign one of these buttons to operate a second device of another type. For example, if you have two VCRs but no satellite receiver, you may program the "SAT" button to operate a second VCR. Before following the normal programming steps for either Three-Digit entry or Auto Search code entry, you must first reassign the button with the following steps:

1. Press the **Input Selector 5** you wish to reassign and the **Mute Button 43** at the same time until the red light appears under the **Input Selector 5** and the **Program/SPL Indicator 3** flashes amber.
2. Press the **Input Selector 5** for the device you wish to program into the reassigned button.
3. Enter the three-digit code for the specific model you wish the reassigned button to operate.
4. Press the same **Input Selector 5** pressed in Step 1 once again to store the selection. The red LED under the re-assigned Input Selector will flash three times and then go out.

Example: To use the CBL/SAT button to operate a second VCR, first press the **CBL/SAT Input Selector 5** and the **Mute Button 43** at the same time until the red light glows under the **CBL/SAT 5** button. Press the **VCR 5 Button**, followed by the three-digit code for the specific model you wish to control. Finally, press the **CBL/SAT Button 5** again.

Resetting the Remote Memory

As you add components to your home-theater system, occasionally you may wish to totally reprogram the remote control without the confusion of any commands, macros or "Punch-Through" programming that you may have done. To do this, it is possible to reset the remote to the original factory defaults and command codes by following these steps. Note, however, that once the remote is reset, all commands or codes that you have entered will be erased and will need to be re-entered:

1. Press any of the **Input Selector Buttons 5** and the **"0" Button 18** at the same time until the **Program/SPL Indicator 3** begins to flash amber.
2. Press the **"3" Button 18** three times.
3. The red LED under the **Input Selector 5** will go out and the **Program/SPL Indicator 3** will stop flashing and turn green.
4. The **Program/SPL Indicator 3** will remain green until the remote is reset. Note that this may take a while, depending on how many commands are in the memory and need to be erased.
5. When the **Program/SPL Indicator 3** goes out, the remote has been reset to the factory settings.

Function List

No.	Button Name	AVR Function	DVD	CD/CD-R	Tape	VCR (VID1)	TV (VID1)	CBL (VID3)	SAT (VID3)
1	Power On	Power On	Power On	Power On	Power On	Power On	Power On	Power On	Power On
2	Power Off	Power Off	Power Off	Power Off	Power Off	Power Off	Power Off	Power Off	Power Off
3	Mute	Mute	Mute	Mute	Mute	Mute	Mute	Mute	Mute
4	AVR	AVR Select							
5	DVD	DVD Input Select	DVD Select						
6	CD	CD Input Select		CD Select					
7	Tape	Tape Input Select			Tape Select				
8	VID 1	Video 1 Select				VCR Select	TV Select	VID3 Select	
9	VID 2	Video 2 Select							
10	VID 3	Video 3 Select							
11	VID 4	Video 4 Select							
12	AM/FM	Tuner Select							
13	6/8 Ch. Select	6/8 Ch. Input Select							
14	Learn								
15	Sleep	Sleep					Channel +	Channel +	Channel +
16	Test	Test Tone	TV/DVD	Input Select		TV/VCR	TV/VCR	TV/Cable	TV/Sat
17	SPL								
18	Volume Up	Volume Up		Input Level Up		Volume Up	Volume Up	Volume Up	Volume Up
19	Surround Select	Surround Mode Select		CD Select		Channel –		Channel –	Channel –
20	Night	Night Mode Select	Subtitle On/Off	CD Select					
21	Multiroom	Multiroom Select							
22	Volume Down	Volume Down		Input Level Down			Volume Down	Volume Down	Volume Down
23	Channel/Guide	Channel Trim	Title					Info/Guide	Info/Guide
24	▲	Move/Adjust Up	Up			Up	Up	Up	Up
25	Speaker/Menu	Speaker Adjust	Menu	Intro Scan		Menu	Menu	Menu	Menu
26	◀	Move/Adjust Left	Left			Left	Left	Left	Left
27	Set	Set	Enter			Enter	Enter	Enter	Enter
28	▶		Right			Right	Right	Right	Right
29	Digital/Exit	Digital Input Select	Open/Close			Exit	Exit	Exit	Exit
30	▼	Move/Adjust Down	Down			Down	Down	Down	Down
31	Delay/Prev. Ch.	Delay Adjust	Return	Open/Close			Prev Channel	Prev Channel	Prev Channel
32	1		1	1		1	1	1	1
33	2		2	2		2	2	2	2
34	3		3	3		3	3	3	3
35	4		4	4		4	4	4	4
36	5		5	5		5	5	5	5
37	6		6	6		6	6	6	6
38	7		7	7		7	7	7	7
39	8		8	8		8	8	8	8
40	Tun-M	Tuner Mode	Chapter	Repeat					
41	9		9	9		9	9	9	9
42	0		0	0		0	0	0	0
43	Memory		Audio	Time					
44	Tune Up	Tune Up	Next Chapter	Track Direct		Cancel	Sleep		
45	Direct	Direct Tuner Entry	Angle	Random Play				FAV	FAV

Function List (continued)

No.	Button Name	AVR Function	DVD	CD/CD-R	Tape	VCR (VID1)	TV (VID1)	CBL (VID3)	SAT (VID3)
46	Clear	Clear	Clear	Clear		Clear	Clear	Bypass	Next
47	Preset Up	Preset Tune Up	Slow Forward	+10				Music	Alt
48	Tune Down	Tune Down	Prev Chapter	Track Increment					
49	OSD	OSD		Program		OSD	OSD	OSD	OSD
50	D. Skip		Disc Skip	Disc Skip					
51	Preset Down	Preset Tune Down	Slow Rev						
52	M1								
53	M2								
54	M3								
55	M4								
56	Dolby	Dolby Modes							
57	DTS SURR	DTS Digital Modes							
58	DTS Neo:6	DTS Neo:6 Select							
59	Logic 7	Logic 7 Select							
60	Stereo	Stereo Mode Select							
61	Skip Down		Skip –	Skip –		Scan –			
62	Skip Up		Skip +	Skip +		Scan +			
63	Rewind		R. Search	R. Search	Rewind	Rewind			
64	Play		Play	Play	Play	Play			
65	Fast Forward		F. Search	F. Search	Fast Fwd	Fast Fwd		Day +	Day +
66	Record			Record	Record	Record			
67	Stop		Stop	Stop	Stop	Stop			
68	Pause		Pause	Pause		Pause			

Setup Code Table: TV

Manufacturer/Brand	Setup Code Number
A MARK	103 132
ADMIRAL	192
AKAI	001 160
AMPRO	070 164
AMSTRAD	053
ANAM	045 055 057 076 095 099 103 106 109 112 122
AOC	001 011 103
BLAUPUNKT	084
BROKSONIC	205 206
CANDLE	001 002 003 011
CAPEHART	059
CENTURION	170 171
CENTRONIC	045
CITIZEN	001 002 003 011 045 092 094 132
CLASSIC	045
CONCERTO	011
CONTEC	041 045 051 052
CORANDO	172
CORONADO	132
CRAIG	045 055 157 158 159
CROWN	045 132
CURTIS MATHES	001 092 107 132
CXC	045
DAEWOO	011 022 023 038 045 046 056 068 073 094 098 102 105 108 111 114 116 118 119 127 132
DAYTRON	107 132
DIGI LINK	200
DYNASTY	045
DYNATECH	063
ELECTROHOME	074 132
EMERSON	001 012 033 045 048 049 051 052 091 107 132 137 139 141 157 158 162 205
FISHER	013 058
FUNAI	033 045
FUTURETECH	045
GE	001 014 015 038 057 070 071 107 121 133 141 145 163 199
GOLDSTAR	011 093 097 101 103 104 107 110 113 118 128 132
GRUNDIG	193
HALL MARK	107
HARMAN KARDON	201
HITACHI	001 011 015 016 017 018 029 043 072 132 144 147
INFINITY	148
INKEL	120
JBL	148
JC PENNEY	001 011 014 015 030 035 092 132 145
JENSEN	019
JVC	038 040 079 134
KAWASHO	173
KEC	045
KENWOOD	001 204
KLOSS	002 060
KMC	132
KTV	001 045 132 162
LLOYTRON	172 173
LODGENET	069
LOGIK	069
LUXMAN	011
LXI	013 021 053 077 145 148
MAGNAVOX	001 003 011 060 061 062 064 065 118 132 145 148
MARANTZ	001 074 148
MATSUI	148
MEMOREX	013 069 107
METZ	084
MGA	001 011 033 044 050 074 107

Setup Code Table: TV (Continued)

Manufacturer/Brand	Setup Code Number
MIDLAND	199
MINERVA	084
MITSUBISHI	001 011 030 033 042 044 100 107 115 154 160 167 168
MTC	175 176
NAD	021 031
NATIONAL	177 178 179 180 181 182
NEC	001 013 022 025 030 042 057 121 123 125
NIKEI	045
ONKING	045
ONWA	045
OPTONICA	025 077
ORION	207 208 209 210 211
PANASONIC	038 057 076 087 148 169
PENNEY	199
PHILCO	001 003 011 030 045 057 060 061 064 065 118 132 148
PHILIPS	001 003 011 040 060 067 088 132 145 148
PIONEER	001 024 029 031 032 107 213 214
PORTLAND	011 132
PROSCAN	133
PROTON	059 107 122 132 165
QUASAR	038 057 087
RADIO SHACK	025 045 048 107 118 132 195 196 197 198
RCA	001 011 029 030 057 071 133 145 161 163 199
REALISTIC	013 025 045 048 195 196 197
RUNCO	152 153
SAA	183
SAMPO	001 059 107
SAMSUNG	051 085 092 096 104 107 118 124 128 132 145
SANYO	013 026 027 037 041 054 058 078
SCOTT	033 045 049 107 132
SEARS	011 013 021 033 035 058 078 092 107 132 145
SHARP	011 020 025 028 033 034 077 132 154
SIEMENS	084
SIGNATURE	069
SONY	043 067 075 117 130 136 194 212
SOUNDESIGN	003 033 045 107
SPECTRICON	103
SSS	011 045
SUPREMACY	002
SYLVANIA	001 003 011 060 061 064 065 107 118 131 145 148
SYMPHONIC	184
TANDY	077
TATUNG	057 063
TECHNICS	080
TECHWOOD	011
TEKNIKA	001 002 003 011 030 033 036 045 069 074 092 094 132
TELEFUNKEN	039 047 083
TELERENT	069
TERA	156
THOMSON	190 191
TMK	011 107
TOSHIBA	013 021 035 042 052 063 092 129 202
TOTEVISION	132
UNIVERSAL	014 015
VIDEO CONCEPTS	160
VIDTECH	011 107
WARDS	011 014 015 025 033 061 062 064 065 069 071 107 132 148
YAMAHA	001 011
YORK	107
YUPITERU	045
ZENITH	069 070 090 094
ZONDA	103

Setup Code Table: VCR

Manufacturer/Brand	Setup Code Number
AIWA	040
AKAI	022 048 050 108 109 126
AMPRO	076
AMSTRAD	133
ANAM	037 039 089
ASA	134
AUDIO DYNAMICS	018 029 044 048
BROKSONIC	041 043 110 147 166
CANDLE	134 135 137
CANON	034 037 039 135 140
CAPEHART	094
CITIZEN	134
CRAIG	003 045 116
CURTIS MATHES	037 039
DAEWOO	012 014 017 068 069 094 096 097 098 102 103 104
DAYTRON	094
DBX	018 029 044 048
DUAL	136
DYNATECH	040 057
ELECTROHOME	063
EMERSON	013 023 031 033 035 037 040 041 042 043 050 087 110 112 119
FERGUSON	136
FINLUX	133
FISHER	003 015 016 017
FUNAI	040 133
GE	037 039 067 076 093 095 124 127
GO VIDEO	113 117
GOLDSTAR	018 019 026 087 092 100 107
GRAETZ	136
HARMAN KARDON	018 049
HITACHI	011 040 048 067 118 130
INSTANT REPLAY	037 039
ITT	136
JCL	037 039
JC PENNEY	018 019 021 039 045 070 087
JENSEN	048
JVC	018 037 039 048 052 054 059 064 111 130 132
KENWOOD	020 044 048 052
LLOYD	040
LXI	019 020 040 087
MAGIN	045
MAGNAVOX	037 039 040 071 072
MARANTZ	018 037 039 071 073
MARTA	087
MATSUI	033 036
MEI	037 039
MEMOREX	003 017 020 037 039 040 057 076 087 115 120
MGA	049 050 063
MINOLTA	019 026
mitsubishi	019 026 049 050 053 055 063 065 131 145 146
MTC	133
MULTITECH	030 040
NAD	139
NATIONAL	140
NEC	018 029 044 048 052

Setup Code Table: VCR (continued)

Manufacturer/Brand	Setup Code Number
NORDMENDE	048
OPTIMUS	159
OPTONICA	057 058
ORION	147 166
PANASONIC	070 074 078 086 114 125 150 167 172
PENTAX	019 026 037 039 067
PHILCO	037 039 040 071
PHILIPS	037 039 040 058 071 075 087
PILOT	087
PIONEER	019 027 052
PORTLAND	094
PULSAR	076
QUARTZ	001 020
QUASAR	039 070 079 125 144
RADIO SHACK	133 134 137 140 141 142 152 158 159 160 161
RCA	019 026 039 066 067 093 095 124 125 127 157 172
REALISTIC	003 015 017 020 037 039 040 045 057 058 087 137 152 159 160
RICO	062
RUNCO	128
SABA	136
SAISHO	143
SALORA	020
SAMSUNG	038 045 088 090 091 093 095 098 099 101 105 106 109
SANSUI	028 048 052 116 147 166
SANYO	003 014 017 020 115
SCHAUB LORENZ	136
SCOTT	023 043 098 110 112
SEARS	003 015 016 017 019 020 026 037 047 077 084 087
SHARP	037 058 129 156
SHINTOM	030
SONY	003 016 037 056 060 061 062 080 081 082 129
SOUNDESIGN	040
STS	019
SYLVANIA	037 039 040 063 071
SYMPHONIC	040
TANDY	017 040
TASHICO	134
TATUNG	044 048
TEAC	040 044 048
TECHNICS	037 039
TEKNIKA	025 037 039 040 087
TELEFUNKEN	136
THOMAS	040
THOMSON	136
THORN	136
TMK	013
TOSHIBA	015 019 047 051 063 085 098 112 155
TOTEVISION	045 087
UNITECH	045
VECTOR RESEARCH	018
VICTOR	052
VIDEO CONCEPTS	018 040 050
VIDEOSONIC	045
WARDS	003 019 023 030 037 039 040 045 057 058 112
YAMAHA	018 040 044 048
ZENITH	040 052 060 062 076 083 087

Setup Code Table: CD

Manufacturer/Brand	Setup Code Number
ADC	012
ADCOM	049 063 069
AIWA	072 111 118 156 170
AKAI	050 177 184
AUDIO TECHNICA	053
AUDIOACCESS	125
AUDIOFILE	211
BSR	044 064
CALIFORNIA AUDIO	015 109
CAPETRONIC	070
CARRERA	064 087
CARVER	051 057 136 140 141 143 144 145 185 186
CASIO	066 117 122 166
CLARINETTE	122 166
CROWN	042
CURTIS MATHES	066
DENON	187 188 213
EMERSON	049 052 093 108
FISHER	023 055 057 068
FRABA	117
FUNAI	126
GE	164
GENEXXA	017 096 108
GOLDSTAR	016 087
HAITAI	099 214
HARMAN KARDON	001 002 025 040 054 190 218 219
HITACHI	049 093
INKEL	026 027 216
JC PENNEY	021 066 098 147
JENSEN	153
JVC	029 176 195 196
KENWOOD	014 020 023 030 062 078 079 148 151 176 178 181
KYOCERA	012
LOTTE	108
LUXMAN	018 035 077 102
LXI	066 164
MAGNAVOX	039 051 113
MARANTZ	043 051 058 084 191 192 193
MCINTOSH	194
MCS	021 066 080 098
MEMOREX	096
MGA	032
MISSION	051
MITSUBISHI	032
MITSUMI	152
MODULAIRE	122 166
NAD	013 074 197 198
NAKAMICHI	199 200 201
NEC	021 069
NIKKO	053 055
NSM	051

Setup Code Table: CD (continued)

Manufacturer/Brand	Setup Code Number
ONKYO	037 038 045 046 171 175 202 203
OPTIMUS	020 036 056 057 064 065 089 090 091 092 096 099 104 212
PANASONIC	015 075 109 119 158 183 204
PHILIPS	039 051 138 149 209
PIONEER	017 036 071 094 096 100 112 123 131 160 161 162 215
PROTON	051 210
QUASAR	015 109
RADIO SHACK	122 126 213
RCA	024 049 081 093 150
RCX	169
REALISTIC	049 056 057 058 093 095 104 105 108 164 166
ROTEL	051
SAE	051
SAMSUNG	028
SANSUI	047 051 081 134 157 172
SANYO	033 057 068 082 095 168
SCOTT	108
SEARS	066
SHARP	020 058 073 105 114 151 159 167 180 181
SHERWOOD	003 026 027 041 058 105 133
SIGNATURE	040
SONY	060 103 115 116 118 132 139 163 205 206 207 208 212 217
SOUNDSTREAM	124
STS	012
SYLVANIA	051
SYMPHONIC	059 110
TAEKWANG	177
TANDY	096
TEAC	011 022 048 058 085 086 106 107 110 121 137 146 154
TECHWOOD	083
THETA DIGITAL	039
TOSHIBA	013 074 097 151 155 173
VECTOR RESEARCH	087
VICTOR	029 120 130
WARDS	040 095
YAMAHA	019 031 053 061 135 169
YORK	122 166

Setup Code Table: Tape

Manufacturer/Brand	Setup Code Number
HARMAN KARDON	001

Setup Code Table: Audio

Manufacturer/Brand	Setup Code Number
HARMAN KARDON	001

Setup Code Table: DVD

Manufacturer/Brand	Setup Code Number
APEX DIGITAL	061
CALIFORNIA AUDIO	040
DENON	002 019 022 034 051
GE	003 004
GOLDSTAR	005
HARMAN KARDON	001 032
JVC	006
KENWOOD	007 050
LG	005 055 064
LOTTE	008
MAGNAVOX	033 056
MARANTZ	033 059
MITSUBISHI	023 036
NAD	010 062
ONKYO	009 015 048
OPTIMUS	011 050
PANASONIC	024 025 030 034 035 044 052
PHILIPS	033 056
PIONEER	012 020 038 041 046 047 065
PROCEED	060
PROSCAN	003 004 037
RCA	003 004 018 037
RUNCO	027
SAMSUNG	031 053 054
SANYO	013 049
SHARP	021 028 050
SONY	015 029 043 045
TECHNICS	026
THOMSON	003 004
TOSHIBA	009 033 047 057 058
YAMAHA	016 017 030 063
ZENITH	005 033 055 064
ZENITH DIVX	039

Setup Code Table: SAT

Manufacturer/Brand	Setup Code Number															
ALPHASTAR	472															
ALPHASTAR DBS	450															
ALPHASTAR DSR	422	442														
AMPLICA	356															
BIRDVIEW	414	425														
BSR	359															
CAPETRONICS	359															
CHANNEL MASTER	320	321	322	325	361											
CHAPARRAL	315	316	319	380	451											
CITOH	360															
CURTIS MATHES	356															
DRAKE	312	313	317	318	413	481										
DX ANTENNA	331	352	362	379	483											
ECHOSTAR	364	395	397	452	453	463	477	478	484	485						
ELECTRO HOME	392															
EUROPLUS	415															
FUJITSU	324	328	329	334												
GENERAL INSTRUMENT	303	311	323	365	403	454	468	474								
HITACHI DBS	455															
HOUSTON TRACKER	463															
HUGHES	372	437														
HYTEK	359															
JANIEL	366															
JERROLD	367	454	464	468												
KATHREIN	410															
LEGEND	453															
LUXOR	368															
MACOM	317	365	369	370	371											
MAGNAVOX	461	473														
MEMOREX	453															
NEXTWAVE	423	424														
NORSAT	373	374														
OPTIMUS	466															
PANASONIC	366	469														
PANASONIC DBS	457															
PANSAT	420															
PERSONAL CABLE	418															
PHILIPS	375															
PICO	407															
PRESIDENT	326	404														
PRIMESTAR	412	454	464	475												
RCA	301	408	436	439	458	465										
REALISTIC	349	377	480													
SAMSUNG	422	442														
SATELLITE SERVICE CO	335	341	353	388												
SCIENTIFIC ATLANTA	339															
SONY	405	438														
STAR CHOICE DBS	459															
STARCAST	347															
SUPER GUIDE	327	423	424													
TEECOM	330	333	378	390	391	393	409									
TOSHIBA	302	426	443	460	461	462	470									
UNIDEN	323	332	348	349	350	351	354	355	381	382	383	389	403	466	479	480
ZENITH	385	386	387	394	419											

Setup Code Table: CBL

Manufacturer/Brand	Setup Code Number
ABC	001 003 011 045 048 052 059 110
ALLEGRO	111
AMERICAST	212
ANTRONIX	021
ARCHER	012 014 021 031 112
BELCOR	113
CABLE STAR	033 113
CENTURION	092
CENTURY	014
CITIZEN	014 111
COLOUR VOICE	069 090
COMBANO	083 084
COMTRONICS	026 037
DIAMOND	030
DIGI	114
EAGLE	027 037 046 186
EASTERN	063 066 070 115
ELECTRICORD	039
EMERSON	112
FOCUS	116
G.I.	001 003 011 015 017 093 095 096 097
GC ELECTRONICS	113
GE	076
GEMINI	015 029 032 060
GENERAL	210
GENERAL INSTRUMENT	168
GOLDEN CHANNEL	037
GOODMIND	112
HAMLIN	055 056 061 099 100 101 117 175 207 208
HITACHI	001 061 188
HOSPITALITY	074 080
JASCO	111
JERROLD	001 002 003 011 015 016 017 073 093 095 096 097 162 167
LINDSAY	118
M-NET	043
MACOM	040 191
MAGNAVOX	017 019 068 082
MEMOREX	058
MOVIE TIME	035 039
NSC	022 035 044 075 190
OAK	023 038 043 059 094 196 197
PACE	179
PANASONIC	050 053 176 177 189 214
PANTHER	114
PARAGON	058
PHILIPS	013 019 020 027 069 085 090
PIONEER	001 041 057 079 119 171 200 209
POPULAR MECHANICS	116
POST NEWS WEEK	023
PRELUDE	120
PRIMESTAR	162
PTS	018 054 075 076

Setup Code Table: CBL (continued)

Manufacturer/Brand	Setup Code Number
PULSAR	058
RADIO SHACK	111 112 213
RCA	053 214
RECOTON	116
REGAL	055 056 061 099 100 101 207
REGENCY	063 115
REMBRANT	032
SAMSUNG	037 072 186
SCIENTIFIC ATLANTA	003 018 047 048 049 051 052 110 183 184 203 204
SEAM	121
SHERITECH	029
SIGNAL	037
SIGNATURE	001 188
SL MARX	037
SPRUCER	053 081 177 189
STARCOM	002 011 015 016 163
STARGATE	015 037 120
SYLVANIA	071
TADIRAN	037
TANDY	024
TELECAPATION	028
TEXSCAN	036 071
TFC	122
TIMELESS	123
TOCOM	045 046 062 170 205
TOSHIBA	058
UNIKA	014 021 031
UNITED CABLE	011 059
UNIVERSAL	012 014 021 031 033 034 039 042 113
VIDEOWAY	124 211
VIEWSTAR	019 022 025 086 087 088 089 190
ZENITH	058 065 098 125 211
ZENTEK	116

Troubleshooting Guide

SYMPTOM	CAUSE	SOLUTION
Unit does not function when Main Power Switch is pushed	<ul style="list-style-type: none"> No AC Power 	<ul style="list-style-type: none"> Make certain AC power cord is plugged into a live outlet Check to see whether outlet is switch-controlled
Display lights, but no sound or picture	<ul style="list-style-type: none"> Intermittent input connections Mute is on Volume control is down 	<ul style="list-style-type: none"> Make certain that all input and speaker connections are secure Press Mute button Turn up volume control
Unit turns on, but front panel display does not light up	<ul style="list-style-type: none"> Display brightness is turned off 	<ul style="list-style-type: none"> Follow the instructions in the Display Brightness section on page 35 so that the display is set to VFD FULL
No sound from any speaker; light around power switch is red	<ul style="list-style-type: none"> Amplifier is in protection mode due to possible short Amplifier is in protection mode due to internal problems 	<ul style="list-style-type: none"> Check speaker wire connections for shorts at receiver and speaker ends Contact your local Harman Kardon service depot
No sound from surround or center speakers	<ul style="list-style-type: none"> Incorrect surround mode Input is monaural Incorrect configuration Stereo or Mono program material 	<ul style="list-style-type: none"> Select a mode other than Stereo There is no surround information from mono sources Check speaker mode configuration The surround decoder may not create center- or rear-channel information from nonencoded programs
Unit does not respond to remote commands	<ul style="list-style-type: none"> Weak batteries in remote Wrong device selected Remote sensor is obscured 	<ul style="list-style-type: none"> Change remote batteries Press the AVR selector Make certain front panel sensor is visible to remote or connect remote sensor
Intermittent buzzing in tuner	<ul style="list-style-type: none"> Local interference 	<ul style="list-style-type: none"> Move unit or antenna away from computers, fluorescent lights, motors or other electrical appliances
Letters flash in the channel indicator display and digital audio stops	<ul style="list-style-type: none"> Digital audio feed paused 	<ul style="list-style-type: none"> Resume play for DVD Check that Digital Input is selected

Processor Reset

In the rare case where the unit's operation or the displays seem abnormal, the cause may involve the erratic operation of the system's memory or microprocessor.

To correct this problem, first unplug the unit from the AC wall outlet and wait at least three minutes. After the pause, reconnect the AC power cord and check the unit's operation. If the system still malfunctions, a system reset may clear the problem.

To clear the AVR 520's entire system memory including tuner presets, output level settings,

delay times and speaker configuration data, first put the unit in Standby by pressing the **System Power Control** button **2**. Next, press and hold the **Tone Mode** **8** and the **FM Mode Selector** **16** buttons for three seconds.

The unit will turn on automatically and display the **RESET** message in the **Main Information Display** **Y**. Note that once you have cleared the memory in this manner, it is necessary to reestablish all system configuration settings and tuner presets.

NOTE: Resetting the processor will erase any configuration settings you have made for

speakers, output levels, surround modes, digital input assignments as well as the tuner presets. After a reset the unit will be returned to the factory presets, and all settings for these items must be reentered.

If the system is still operating incorrectly, there may have been an electronic discharge or severe AC line interference that has corrupted the memory or microprocessor.

If these steps do not solve the problem, consult an authorized Harman Kardon service depot.

Technical Specifications

Audio Section

Stereo Mode	
Continuous Average Power (FTC)	
85 Watts per channel, 20Hz–20kHz, @ < 0.07% THD, both channels driven into 8 ohms	
Five-Channel Surround Modes	
Power Per Individual Channel	
Front L&R channels:	
75 Watts per channel	
@ < 0.07% THD, 20Hz–20kHz into 8 ohms	
Center channel:	
75 Watts @ < 0.07% THD, 20Hz–20kHz into 8 ohms	
Surround channels:	
75 Watts per channel	
@ < 0.07% THD, 20Hz–20kHz into 8 ohms	
Input Sensitivity/Impedance	
Linear (High-Level)	200mV/47k ohms
Signal-to-Noise Ratio (IHF-A)	95dB
Surround System Adjacent Channel Separation	
Analog Decoding	40dB
(Pro Logic II, etc.)	
Dolby Digital (AC-3)	55dB
DTS	55dB
Frequency Response	
@ 1W (+0dB, –3dB)	10Hz – 100kHz
High Instantaneous	
Current Capability (HCC)	±45 Amps
Transient Intermodulation	
Distortion (TIM)	Unmeasurable
Rise Time	16 µsec
Slew Rate	40V/µsec

FM Tuner Section

Frequency Range	87.5–108MHz
Usable Sensitivity	IHF 1.3 µV/13.2dB
Signal-to-Noise Ratio	Mono/Stereo 70/68dB
Distortion	Mono/Stereo 0.2/0.3%
Stereo Separation	40dB @ 1kHz
Selectivity	±400kHz, 70dB
Image Rejection	80dB
IF Rejection	90dB
Tuner Output Level	1kHz, ±75kHz Dev 500mV

AM Tuner Section

Frequency Range	520–1710kHz
Signal-to-Noise Ratio	45dB
Usable Sensitivity	Loop 500µV
Distortion	1kHz, 50% Mod 0.8%
Selectivity	±10kHz, 30dB

Video Section

Television Format	NTSC
Input Level/Impedance	1Vp-p/75 ohms
Output Level/Impedance	1Vp-p/75 ohms
Video Frequency Response (Composite and S)	10Hz–8MHz (–3dB)
Video Frequency Response (Component)	10Hz–30MHz (–3dB)

General

Power Requirement	AC 120V/60Hz
Power Consumption	78W idle, 694W maximum (2 channels driven)
Dimensions (Max)	
Width	17.3 inches (440mm)
Height	6.5 inches (165mm)
Depth	17.1 inches (435mm)
Weight	35 lb (15.9 kg)

Depth measurement includes knobs, buttons and terminal connections.
Height measurement includes feet and chassis.
All features and specifications are subject to change without notice.

Harman Kardon is a registered trademark, and Power for the Digital Revolution is a trademark, of Harman Kardon, Inc.

IIIIEzSet is a trademark of Harman International Industries, Inc. (Patent No. 5,386,478).

*Manufactured under license from Dolby Laboratories.

"Dolby," "Pro Logic," "Pro Logic II" and the Double-D symbol are trademarks of Dolby Laboratories. Confidential Unpublished Works. ©1992–1999 Dolby Laboratories, Inc. All rights reserved.

DTS, DTS Surround, DTS-ES and DTS Neo:6 are trademarks of Digital Theater Systems, Inc.

UltraStereo is a trademark of UltraStereo Corp.

VMAx is a registered trademark of Harman International Industries, Inc., and is an implementation of Cooper Bauck Transaural Stereo under patent license.

Logic 7 is a registered trademark of Lexicon, Inc.

Crystal is a registered trademark of Cirrus Logic Corp.

HDCD system manufactured under license from Pacific Microsonics, Inc. This product is covered by one or more of the following: In the USA: 5,479,168; 5,638,074; 5,640,161; 5,808,574; 5,838,274; 5,854,600; 5,864,311; 5,872,531; and in Australia: 669114. Other patents pending.

harman/kardon

H A Harman International Company
250 Crossways Park Drive, Woodbury, New York 11797
www.harmankardon.com
© 2002 Harman Kardon, Incorporated
Part No.: J90200022100
Rev. 1 (02/2002)